

# PIN RECEPTACLES

FOR 0,38 - 0,64 DIAMETER PINS

## 7132

7132-0-15-XX-30-XX-04-0

Square press-fit for  $0,81 \pm 0,05$  plated through-hole

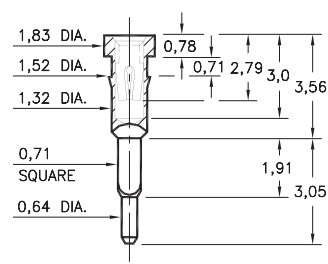

## 8445

8445-0-15-XX-30-XX-04-0

Square press-fit for  $0,99 \pm 0,05$  plated through-hole

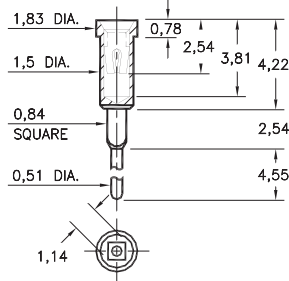

## 1038

1038-0-15-XX-30-XX-04-0

Press-fit in 1,5 mounting hole

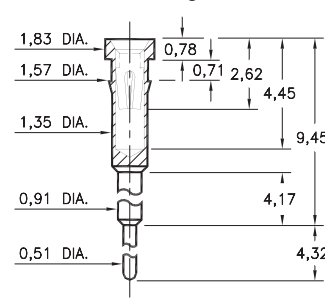

## 1261

1261-0-15-XX-30-XX-04-0

Press-fit in 1,45 mounting hole

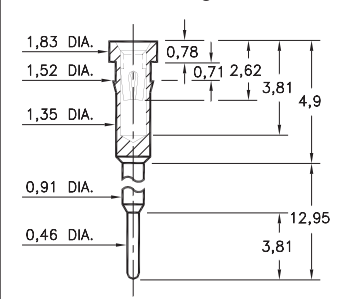

## 0153

0153-X-15-XX-30-XX-04-0

Press-fit in 1,45 mounting hole

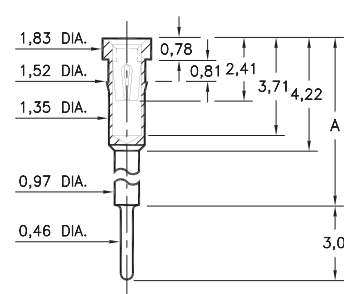

Basic Part Number	Height A
0153-1	5,99
0153-2	8,0
0153-3	10,21
0153-4	11,99
0153-5	15,09
0153-6	17,75

## 1602/1610

16XX-0-15-XX-30-XX-04-0

Press-fit in 1,45 mounting hole

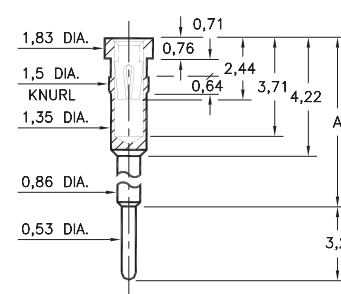

Basic Part Number	Height A
1602-0	11,2
1610-0	16,31

## 0903/0904

090X-0-15-XX-30-XX-04-0

Press-fit in 1,45 mounting hole

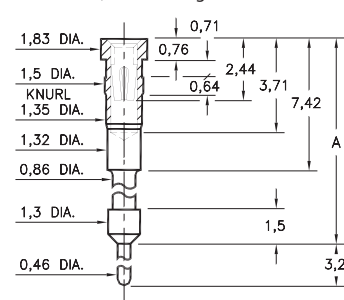

Basic Part Number	Height A
0903-0	21,36
0904-0	28,98

## 8252

8252-0-15-XX-30-XX-10-0

Press-fit in 1,45 plated through-hole

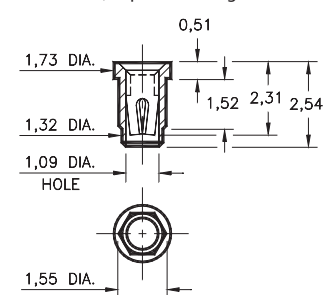

## 4078

4078-0-15-XX-30-XX-40-0

Press-fit in 1,45 mounting hole

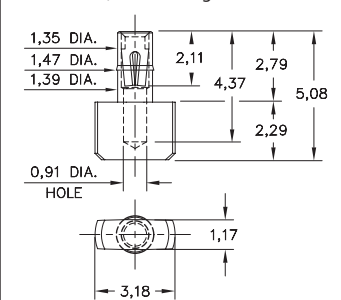

### SPECIFICATIONS:

Shell Material: Brass Alloy 360, 1/2 Hard

Contact Material: Beryllium Copper Alloy 172, HT

Dimensions: Millimeters

Tolerances On: Lengths:  $\pm 0,13$

Diameters:  $\pm 0,051$

Angles:  $\pm 2^\circ$



ORDER CODE: **XXXX - X - 15 - XX - 30 - XX - XX - 0**

BASIC PART #

SPECIFY SHELL FINISH:

01 5,08 $\mu$ m TIN/LEAD OVER NICKEL

◆ 80 5,08 $\mu$ m TIN OVER NICKEL (RoHS)

◆ 15 0,25 $\mu$ m GOLD OVER NICKEL (RoHS)

SPECIFY CONTACT FINISH:

02 2,54 $\mu$ m TIN/LEAD OVER NICKEL

◆ 84 2,54 $\mu$ m TIN OVER NICKEL (RoHS)

◆ 27 0,76 $\mu$ m GOLD OVER NICKEL (RoHS)

SELECT CONTACT:

#30 CONTACT (DATA ON PAGE 253)

(For alternate contact choices, see groups B and C on page 248)

