

FAN1587A

3A Adjustable/Fixed Low Dropout Linear Regulator

Features

- Fast transient response
- Low dropout voltage at up to 3A
- Load regulation: 0.05% typical
- Trimmed current limit
- On-chip thermal limiting
- Standard TO-220, TO-263, TO-263 center cut, and TO-252 packages

Applications

- Pentium® Class GTL+ bus supply
- Low voltage logic supply
- Post regulator for switching supply
- 12V to 5V linear regulator
- 3.3V to 1.5V linear regulator

Description

The FAN1587A, FAN1587A-1.5, and FAN1587A-3.3 are low dropout three-terminal regulators with 3A output current capability. These devices have been optimized for low voltage applications including VTT bus termination, where transient response and minimum input voltage are critical. The FAN1587A is ideal for low voltage microprocessor applications requiring a regulated output from 1.5V to 3.6V with an input supply of 12V or less. The FAN1587A-1.5 offers fixed 1.5V with 3A current capability for GTL+ bus VTT termination. The FAN1587A-3.3 offers fixed 3.3V current capability for logic IC operation.

Current limit is trimmed to ensure specified output current and controlled short-circuit current. On-chip thermal limiting provides protection against any combination of overload and ambient temperature that would create excessive junction temperatures.

The FAN1587A, FAN1587A-1.5, and FAN1587A-3.3 are available in the industry-standard TO-220, TO-263, TO-263 center cut, and TO-252 (DPAK) power packages.

Typical Applications

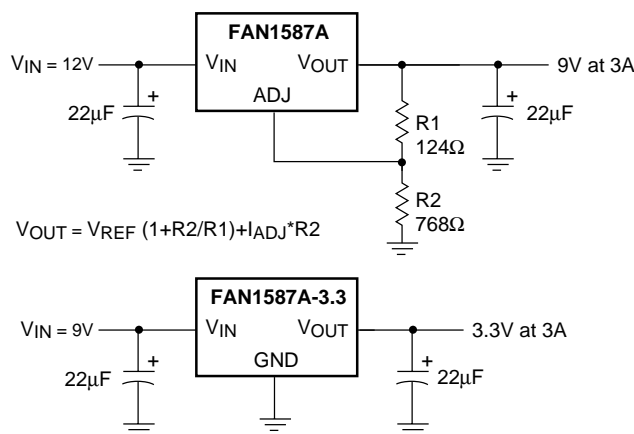

65-1587-16

Pin Assignments

FAN1587AM-1.5
FRONT VIEW

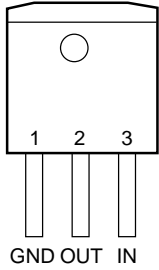

FAN1587AM
FRONT VIEW

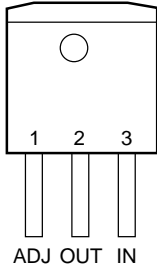

Tab is Out.

3-Lead Plastic TO-263
 $\theta_{JC} = 3^{\circ}\text{C/W}^*$

FAN1587AT
FRONT VIEW

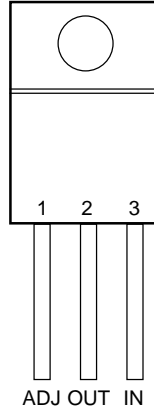

FAN1587AT-1.5, -3.3V
FRONT VIEW

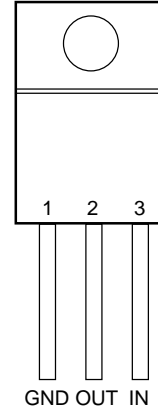

Tab is Out.

3-Lead Plastic TO-220
 $\theta_{JC} = 3^{\circ}\text{C/W}$

FAN1587AMC-1.5, 3.3

FRONT VIEW

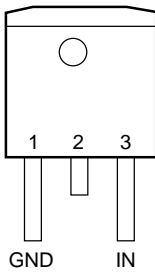

FAN1587AMC

FRONT VIEW

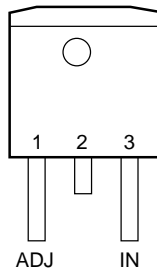

Tab is Out.

3-Lead Plastic TO-263 Center Cut
 $\theta_{JC} = 3^{\circ}\text{C/W}^*$

FAN1587AD-1.5, 3.3

FRONT VIEW

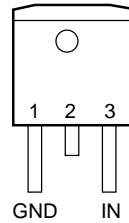

FAN1587AD

FRONT VIEW

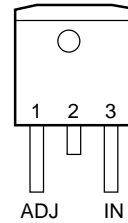

Tab is Out.

3-Lead Plastic TO-252
 $\theta_{JC} = 3^{\circ}\text{C/W}^*$

*With package soldered to 0.5 square inch copper area over backside ground plane or internal power plane, θ_{JA} can vary from 30°C/W to more than 40°C/W . Other mounting techniques can provide a thermal resistance lower than 30°C/W .

Absolute Maximum Ratings

Parameter	Min.	Max.	Unit
V _{IN}		18	V
(V _{IN} - V _{OUT}) * I _{OUT}		See Figure 1	
Operating Junction Temperature Range	0	125	°C
Storage Temperature Range	-65	150	°C
Lead Temperature (Soldering, 10 sec.)		300	°C

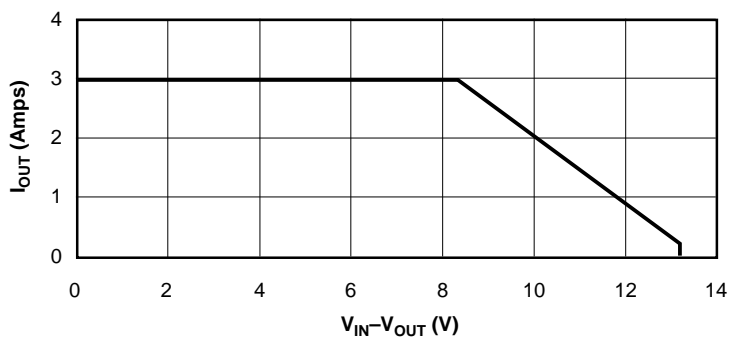

Figure 1. Absolute Maximum Safe Operating Area

Electrical Characteristics

T_j = 25°C unless otherwise specified.

The • denotes specifications which apply over the specified operating temperature range.

Parameter	Conditions		Min.	Typ.	Max	Units
Reference Voltage ³	$1.5V \leq (V_{IN} - V_{OUT}) \leq 8.25V$, $10mA \leq I_{OUT} \leq 3A$	•	1.225 (-2%)	1.250	1.275 (+2%)	V
Output Voltage ^{4, 6}	$3.0V \leq V_{IN} \leq 8.5V$ $10mA \leq I_{OUT} \leq 3A$	•	1.47	1.5	1.53	V
Output Voltage ^{5, 6}	$4.8V \leq V_{IN} \leq 10.3V$ $10mA \leq I_{OUT} \leq 3A$	•	3.234	3.3	3.366	V
Line Regulation ^{1, 2}	$(V_{OUT} + 1.5V) \leq V_{IN} \leq 12V$, $I_{OUT} = 10mA$	•		0.005	0.2	%
Load Regulation ^{1, 2}	$(V_{IN} - V_{OUT}) = 3V$ $10mA \leq I_{OUT} \leq 3A$	•		0.05	0.5	%
Dropout Voltage	$\Delta V_{REF} = 1\%$, $I_{OUT} = 3A$	•		1.150	1.300	V
Current Limit	$(V_{IN} - V_{OUT}) = 2V$	•	3.1	4		A
Adjust Pin Current ³		•		35	120	μA
Adjust Pin Current Change ^{3, 6}	$1.5V \leq (V_{IN} - V_{OUT}) \leq 12V$, $10mA \leq I_{OUT} \leq 3A$	•		0.2	5	μA
Minimum Load Current	$1.5V \leq (V_{IN} - V_{OUT}) \leq 12V$	•	10			mA
Quiescent Current	$V_{IN} = 5V$	•		4	13	mA
Ripple Rejection	$f = 120Hz$, $C_{OUT} = 22\mu F$ Tantalum, $(V_{IN} - V_{OUT}) = 3V$, $I_{OUT} = 3A$		60	72		dB
Thermal Regulation	$T_A = 25^\circ C$, 30ms pulse			0.004	0.02	%/W
Temperature Stability		•		0.5		%
Long-Term Stability	$T_A = 125^\circ C$, 1000 hrs.			0.03	1.0	%
RMS Output Noise (% of V _{OUT})	$T_A = 25^\circ C$, $10Hz \leq f \leq 10kHz$			0.003		%
Thermal Resistance, Junction to Case	TO-220			3		°C/W
	TO-263, TO-252			3		°C/W
Thermal Shutdown				150		°C

Notes:

- See thermal regulation specifications for changes in output voltage due to heating effects. Load and line regulation are measured at a constant junction temperature by low duty cycle pulse testing.
- Line and load regulation are guaranteed up to the maximum power dissipation (18W). Power dissipation is determined by input/output differential and the output current. Guaranteed maximum output power will not be available over the full input/output voltage range.
- FAN1587A only.
- FAN1587A-1.5 only.
- FAN1587A-3.3 only.
- Output current must be limited to meet the absolute maximum ratings of the part.

Typical Performance Characteristics

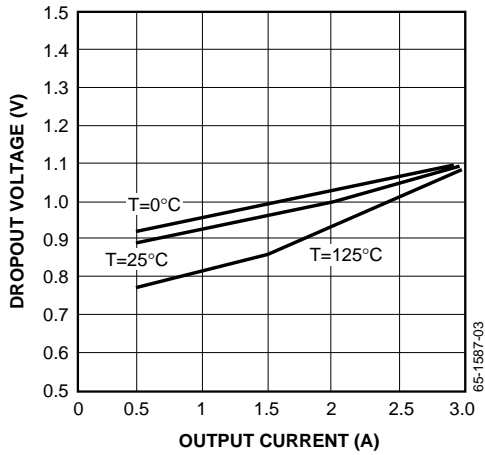

Figure 2. Dropout Voltage vs. Output Current

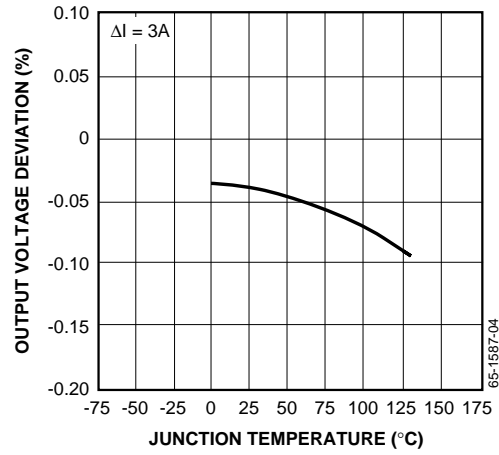

Figure 3. Load Regulation vs. Temperature

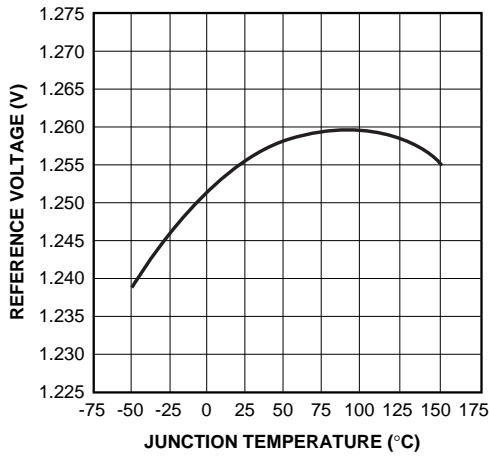

Figure 4. Reference Voltage vs. Temperature

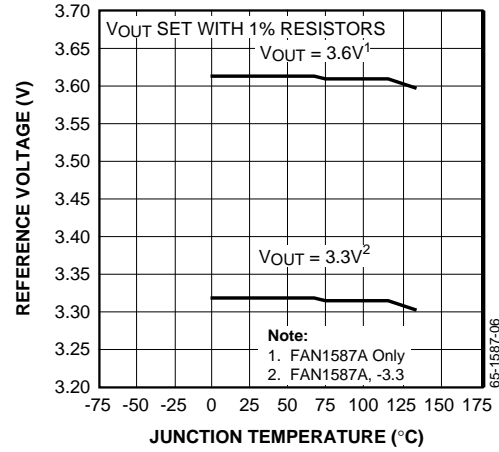

Figure 5. Output Voltage vs. Temperature

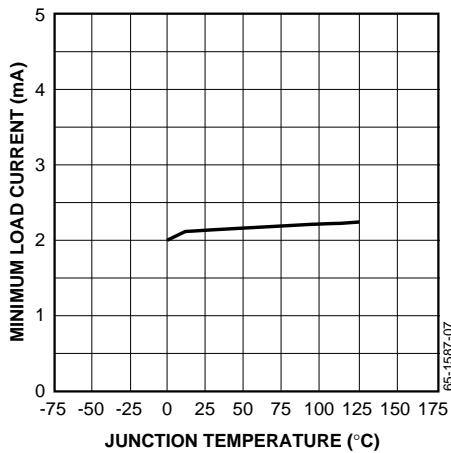

Figure 6. Minimum Load Current vs. Temperature

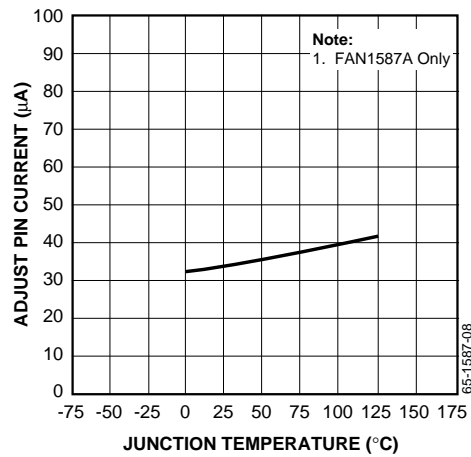

Figure 7. Adjust Pin Current vs. Temperature

Typical Performance Characteristics (continued)

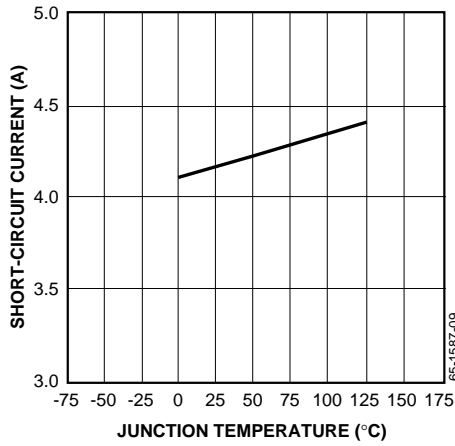

Figure 8. Short-Circuit Current vs. Temperature

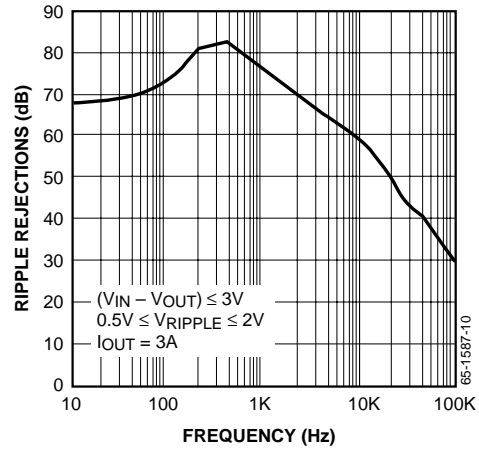

Figure 9. Ripple Rejection vs. Frequency

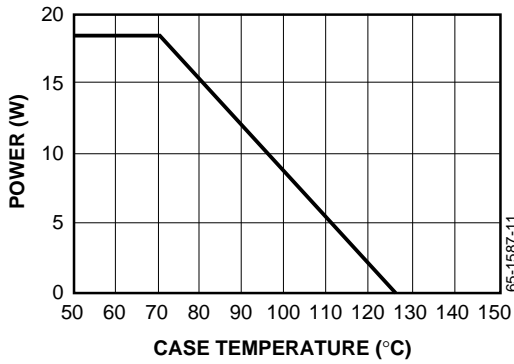

Figure 10. Maximum Power Dissipation

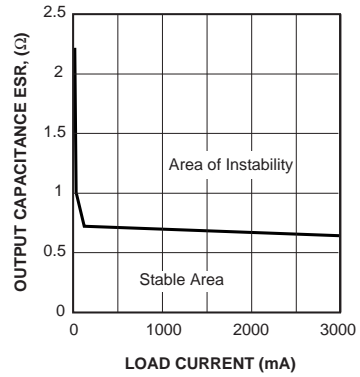

Figure 11. Stability Region $V_{IN}/V_{OUT} = 5V/1.5V$

Applications Information

General

The FAN1587A, FAN1587A-1.5, and FAN1587A-3.3 are three-terminal regulators optimized for GTL+ VTT termination applications. These devices are short-circuit protected, and offer thermal shutdown to turn off the regulator when the junction temperature exceeds about 150°C. The FAN1587A series provides low dropout voltage and fast transient response. Frequency compensation uses capacitors with low ESR while still maintaining stability. This is critical in addressing the needs of low voltage high speed microprocessor buses like GTL+.

Stability

The FAN1587A series require an output capacitor as a part of the frequency compensation. It is recommended to use a 22µF solid tantalum or a 100µF aluminum electrolytic on the output to ensure stability. The frequency compensation of these devices optimizes the frequency response with low ESR capacitors. It is recommended to use bypass capacitors such as a 22µF tantalum or a 100µF aluminum on the adjust pin of the FAN1587A for low ripple and fast transient response. When these bypassing capacitors are not used at the adjust pin, larger values of output capacitors provide equally good results. Refer to Typical Performance Characteristics for graph of stability of output capacitance ESR vs load current.

Protection Diodes

In normal operation, the FAN1587A series does not require any protection diodes. For the FAN1587A, internal resistors limit internal current paths on the adjust pin. Therefore, even with bypass capacitors on the adjust pin, no protection diode is needed to ensure device safety under shortcircuit conditions.

A protection diode between the input and output pins is usually not needed. An internal diode between the input and output pins on the FAN1587A series can handle microsecond surge currents of 50A to 100A. Even with large value output capacitors it is difficult to obtain those values of surge currents in normal operation. Only with large values of output capacitance, such as 1000µF to 5000µF, and with the input pin instantaneously shorted to ground can damage occur. A crowbar circuit at the input can generate those levels of current; a diode from output to input is then recommended, as shown in Figure 11. Usually, normal power supply cycling or system “hot plugging and unplugging” will not generate current large enough to do any damage.

The adjust pin can be driven on a transient basis ±7V with respect to the output, without any device degradation. As with any IC regulator, exceeding the maximum input-to-output voltage differential causes the internal transistors to break down and none of the protection circuitry is then functional.

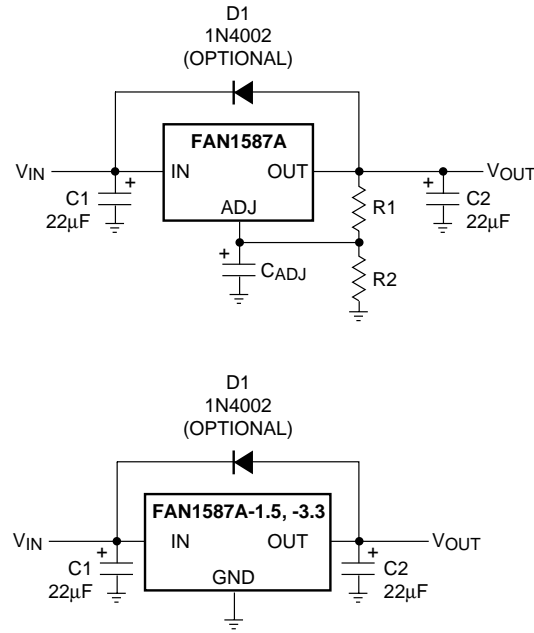

65-1587-13

Figure 11. Optional Protection

Ripple Rejection

In applications that require improved ripple rejection, a bypass capacitor from the adjust pin of the FAN1587A to ground reduces the output ripple by the ratio of $V_{OUT}/1.25V$. The impedance of the adjust pin capacitor at the ripple frequency should be less than the value of R1 (typically in the range of 100Ω to 120Ω) in the feedback divider network in Figure 11. Therefore, the value of the required adjust pin capacitor is a function of the input ripple frequency. For example, if R1 equals 100Ω and the ripple frequency equals 120Hz, the adjust pin capacitor should be 22µF. At 10kHz, only 0.22µF is needed.

Output Voltage

The FAN1587A regulator develops a 1.25V reference voltage between the output pin and the adjust pin (see Figure 12). Placing a resistor R1 between these two terminals causes a constant current to flow through R1 and down through R2 to set the overall output voltage. Normally, this current is the specified minimum load current of 10mA.

The current out of the adjust pin adds to the current from R1 and is typically 35µA. Its output voltage contribution is small and only needs consideration when very precise output voltage setting is required.

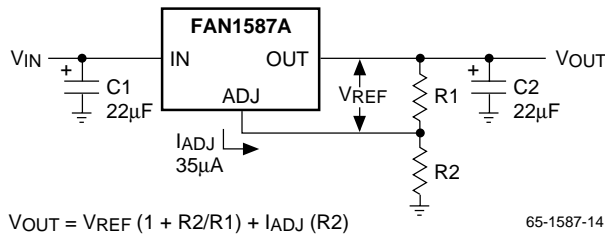

$$V_{OUT} = V_{REF} (1 + R2/R1) + I_{ADJ} (R2)$$

Figure 12. Basic Regulator Circuit

Load Regulation

It is not possible to provide true remote load sensing because the FAN1587A series are three-terminal devices. Load regulation is limited by the resistance of the wire connecting the regulators to the load. Load regulation per the data sheet specification is measured at the bottom of the package.

For fixed voltage devices, negative side sensing is a true Kelvin connection with the ground pin of the device returned to the negative side of the load. This is illustrated in Figure 13.

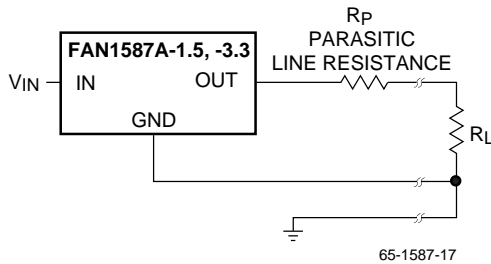

Figure 13. Connection for Best Load Regulation

For adjustable voltage devices, negative side sensing is a true Kelvin connection with the bottom of the output divider returned to the negative side of the load. The best load regulation is obtained when the top of resistor divider R1 connects directly to the regulator output and not to the load. Figure 14 illustrates this point.

If R1 connects to the load, then the effective resistance between the regulator and the load would be:

$$R_p \times (1 + R2/R1), R_p = \text{Parasitic Line Resistance}$$

The connection shown in Figure 14 does not multiply R_p by the divider ratio. As an example, R_p is about four milliohms per foot with 16-gauge wire. This translates to 4mV per foot at 1A load current. At higher load currents, this drop represents a significant percentage of the overall regulation. It is important to keep the positive lead between the regulator and the load as short as possible and to use large wire or PC board traces.

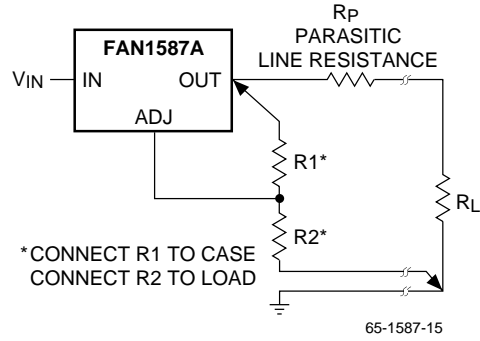

Figure 14. Connection for Best Load Regulation

Thermal Considerations

The FAN1587A series protect themselves under overload conditions with internal power and thermal limiting circuitry. However, for normal continuous load conditions, do not exceed maximum junction temperature ratings. It is important to consider all sources of thermal resistance from junction-to-ambient. These sources include the junction-to-case resistance, the case-to-heat sink interface resistance, and the heat sink resistance. Thermal resistance specifications have been developed to more accurately reflect device temperature and ensure safe operating temperatures.

For example, look at using an FAN1587AT to generate 3A @ 1.5V ± 2% from a 3.3V source (3.2V to 3.6V).

Assumptions:

- $V_{IN} = 3.6V$ worst case
- $V_{OUT} = 1.46V$ worst case
- $I_{OUT} = 3A$ continuous
- $T_A = 70^\circ C$
- $\theta_{Case-to-Ambient} = 3^\circ C/W$ (assuming both a heatsink and a thermally conductive material)

The power dissipation in this application is:

$$P_D = (V_{IN} - V_{OUT}) * (I_{OUT}) = (3.6 - 1.46) * (3) = 6.42W$$

From the specification table:

$$T_J = T_A + (P_D) * (\theta_{Case-to-Ambient} + \theta_{JC}) = 70 + (6.42) * (3 + 3) = 109^\circ C$$

The junction temperature is below the maximum rating.

Junction-to-case thermal resistance is specified from the IC junction to the bottom of the case directly below the die. This is the lowest resistance path for heat flow. Proper mounting ensures the best thermal flow from this area of the package to the heat sink. Use of a thermally conductive material at the

case-to-heat sink interface is recommended. Use a thermally conductive spacer if the case of the device must be electrically isolated and include its contribution to the total thermal resistance. The cases of the FAN1587A series are directly connected to the output of the device.

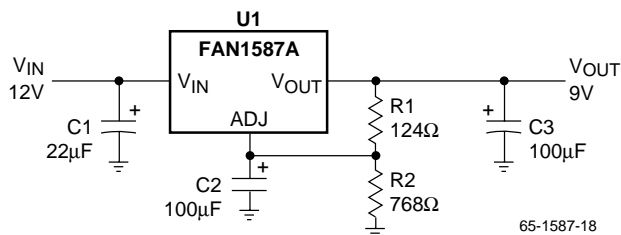

Figure 15. Application Circuit (FAN1587A)

Table 1. Bill of Materials for Application Circuit for the FAN1587A

Item	Quantity	Manufacturer	Part Number	Description
C1	1	Xicon	L16V22	22µF, 16V Aluminum
C2, C3	2	Xicon	L10V100	100µF, 10V Aluminum
R1	1	Generic		124Ω, 1%
R2	1	Generic		768Ω, 1%
U1	1	Fairchild	FAN1587AT	3A Regulator

Mechanical Dimensions (continued)

3-Lead TO-263 Center Cut Package

Symbol	Inches		Millimeters		Notes
	Min.	Max.	Min.	Max.	
A	.160	.190	4.06	4.83	
b	.020	.036	0.51	0.91	
b2	.049	.051	1.25	1.30	
c2	.045	.055	1.14	1.40	
D	.340	.380	8.64	9.65	
E	.380	.405	9.65	10.29	
e	.100 BSC		2.54 BSC		
L	.575	.625	14.61	15.88	
L1	.090	.110	2.29	2.79	
L2	—	.055	—	1.40	
L3	.050	.070	1.27	1.78	
R	.017	.019	0.43	0.78	
α	0°	8°	0°	8°	

Notes:

1. Dimensions are exclusive of mold flash and metal burrs.
2. Standoff-height is measured from lead tip with ref. to Datum -B-.
3. Foot length is measured with ref. to Datum -A- with lead surface (at inner R).
4. Dimension exclusive of dambar protrusion or intrusion.
5. Formed leads to be planar with respect to one another at seating place -C-.

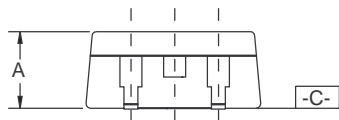
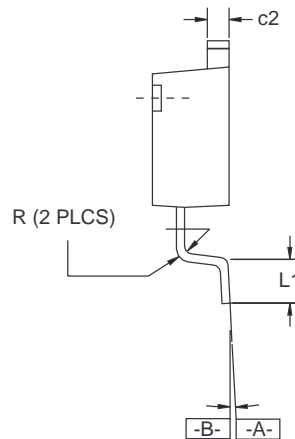
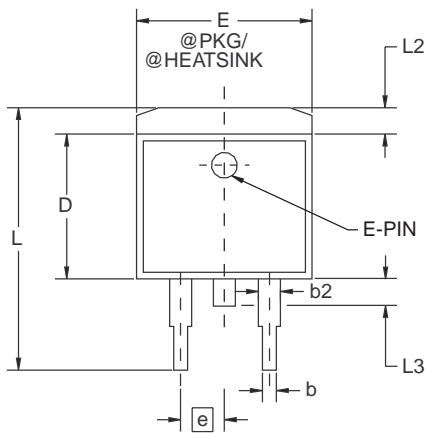

Mechanical Dimensions (continued)

3-Lead TO-220 Package

Symbol	Inches		Millimeters		Notes
	Min.	Max.	Min.	Max.	
A	.140	.190	3.56	4.83	
b	.015	.040	.38	1.02	
b1	.045	.070	1.14	1.78	
c1	.014	.022	.36	.56	
øP	.139	.161	3.53	4.09	
D	.560	.650	14.22	16.51	
E	.380	.420	9.65	10.67	
e	.090	.110	2.29	2.79	
e1	.190	.210	4.83	5.33	
e3	.045	—	1.14	—	
F	.020	.055	.51	1.40	
H1	.230	.270	5.94	6.87	
J1	.080	.115	2.04	2.92	
L	.500	.580	12.70	14.73	
L1	.250 BSC		6.35 BSC		
Q	.100	.135	2.54	3.43	
α	3°	7°	3°	7°	

Notes:

1. Dimension c1 apply for lead finish.

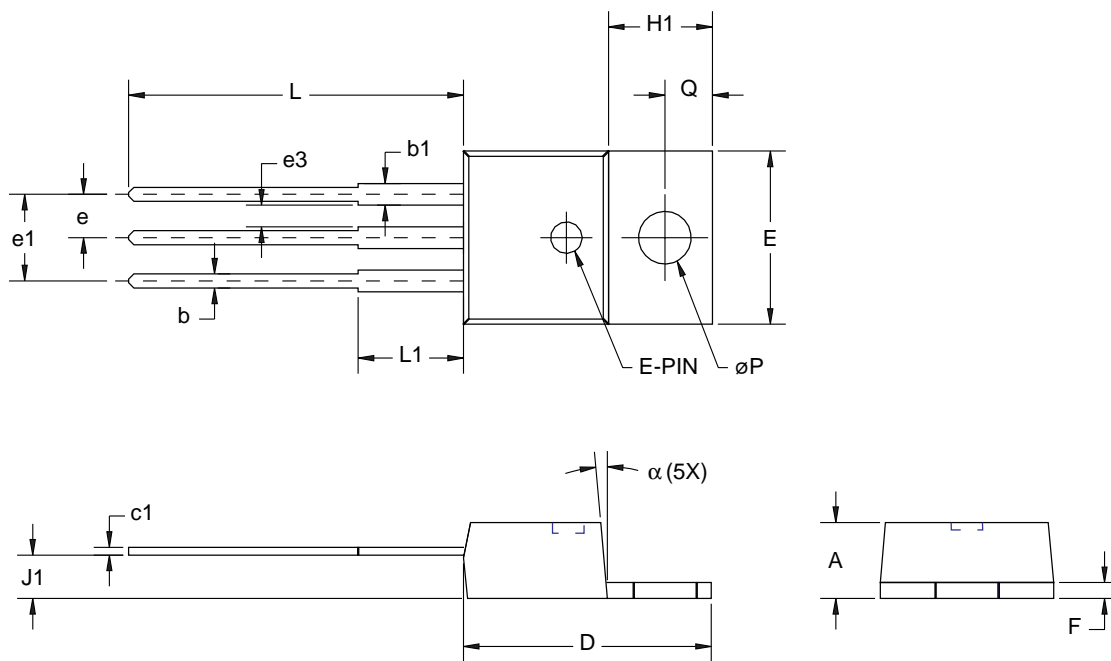

Mechanical Dimensions (continued)

3-Lead TO-252 Package

Symbol	Inches		Millimeters		Notes
	Min.	Max.	Min.	Max.	
A	.086	.094	2.19	2.39	
b	.025	.035	0.64	0.89	
b2	.030	.045	0.76	1.14	
b3	.205	.215	5.21	5.46	4
c	.018	.024	0.46	0.61	
c2	.018	.023	0.46	0.58	
D	.210	.245	5.33	6.22	1
E	.250	.265	6.35	6.73	1
e	.090 BSC		2.29 BSC		
H	.370	.410	9.40	10.41	
L	.055	.070	1.40	1.78	3
L1	.108 REF		2.74 REF		
L3	.035	.080	0.89	2.03	4
L4	.025	.040	0.64	1.02	

Notes:

1. Dimensions are exclusive of mold flash, metal burrs or interlead protrusion.
2. Stand off-height is measured from lead tip with ref. to Datum -B-.
3. Foot length is measured with ref. to Datum -A- with lead surface.
4. Thermal pad contour optional within dimension b3 and L3.
5. Formed leads to be planar with respect to one another at seating place -C-.
6. Dimensions and tolerances per ASME Y14.5M-1994.

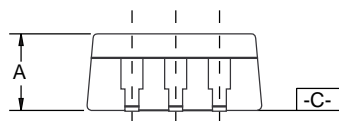
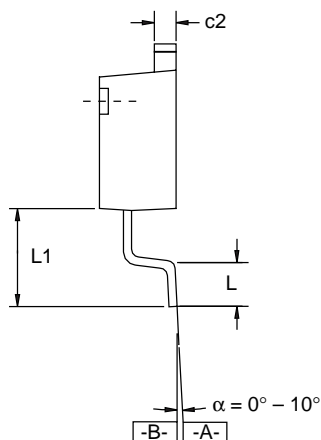
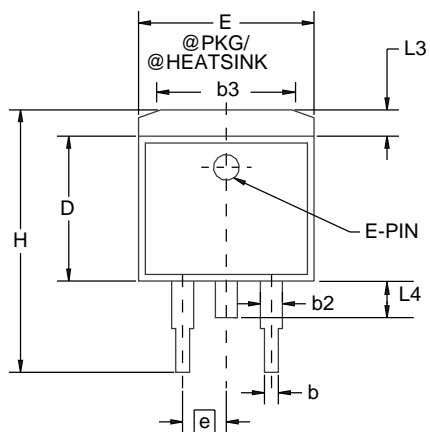

Ordering Information

Product Number	Package
FAN1587AMX	TO-263 in tape-and-reel
FAN1587AMCX	TO-263 center cut in tape-and-reel
FAN1587AT	TO-220
FAN1587ADX	TO-252 in tape-and-reel
FAN1587AM15X	TO-263 in tape-and-reel
FAN1587AMC15X	TO-263 center cut in tape-and-reel
FAN1587AT15	TO-220
FAN1587AD15X	TO-252 in tape-and-reel
FAN1587AM33X	TO-263 in tape-and-reel
FAN1587AMC33X	TO-263 center cut in tape-and-reel
FAN1587AT33	TO-220
FAN1587AD33X	TO-252 in tape-and-reel

DISCLAIMER

FAIRCHILD SEMICONDUCTOR RESERVES THE RIGHT TO MAKE CHANGES WITHOUT FURTHER NOTICE TO ANY PRODUCTS HEREIN TO IMPROVE RELIABILITY, FUNCTION OR DESIGN. FAIRCHILD DOES NOT ASSUME ANY LIABILITY ARISING OUT OF THE APPLICATION OR USE OF ANY PRODUCT OR CIRCUIT DESCRIBED HEREIN; NEITHER DOES IT CONVEY ANY LICENSE UNDER ITS PATENT RIGHTS, NOR THE RIGHTS OF OTHERS.

LIFE SUPPORT POLICY

FAIRCHILD'S PRODUCTS ARE NOT AUTHORIZED FOR USE AS CRITICAL COMPONENTS IN LIFE SUPPORT DEVICES OR SYSTEMS WITHOUT THE EXPRESS WRITTEN APPROVAL OF THE PRESIDENT OF FAIRCHILD SEMICONDUCTOR CORPORATION. As used herein:

1. Life support devices or systems are devices or systems which, (a) are intended for surgical implant into the body, or (b) support or sustain life, and (c) whose failure to perform when properly used in accordance with instructions for use provided in the labeling, can be reasonably expected to result in a significant injury of the user.
2. A critical component in any component of a life support device or system whose failure to perform can be reasonably expected to cause the failure of the life support device or system, or to affect its safety or effectiveness.