



Is Now Part of



ON Semiconductor®

To learn more about ON Semiconductor, please visit our website at
www.onsemi.com

ON Semiconductor and the ON Semiconductor logo are trademarks of Semiconductor Components Industries, LLC dba ON Semiconductor or its subsidiaries in the United States and/or other countries. ON Semiconductor owns the rights to a number of patents, trademarks, copyrights, trade secrets, and other intellectual property. A listing of ON Semiconductor's product/patent coverage may be accessed at www.onsemi.com/site/pdf/Patent-Marking.pdf. ON Semiconductor reserves the right to make changes without further notice to any products herein. ON Semiconductor makes no warranty, representation or guarantee regarding the suitability of its products for any particular purpose, nor does ON Semiconductor assume any liability arising out of the application or use of any product or circuit, and specifically disclaims any and all liability, including without limitation special, consequential or incidental damages. Buyer is responsible for its products and applications using ON Semiconductor products, including compliance with all laws, regulations and safety requirements or standards, regardless of any support or applications information provided by ON Semiconductor. "Typical" parameters which may be provided in ON Semiconductor data sheets and/or specifications can and do vary in different applications and actual performance may vary over time. All operating parameters, including "Typicals" must be validated for each customer application by customer's technical experts. ON Semiconductor does not convey any license under its patent rights nor the rights of others. ON Semiconductor products are not designed, intended, or authorized for use as a critical component in life support systems or any FDA Class 3 medical devices or medical devices with a same or similar classification in a foreign jurisdiction or any devices intended for implantation in the human body. Should Buyer purchase or use ON Semiconductor products for any such unintended or unauthorized application, Buyer shall indemnify and hold ON Semiconductor and its officers, employees, subsidiaries, affiliates, and distributors harmless against all claims, costs, damages, and expenses, and reasonable attorney fees arising out of, directly or indirectly, any claim of personal injury or death associated with such unintended or unauthorized use, even if such claim alleges that ON Semiconductor was negligent regarding the design or manufacture of the part. ON Semiconductor is an Equal Opportunity/Affirmative Action Employer. This literature is subject to all applicable copyright laws and is not for resale in any manner.



FSB43004A Motion SPM[®] 45 LV Series

Features

- UL Certified No.E209204(UL1557)
- 40 V, $R_{DS(ON)}=3.0\text{ m}\Omega(\text{max.})$ 3-phase MOSFET Inverter Module Including Control IC for Gate Drive and Protection.
- Ceramic Substrate.
- Three Separate Open-Emitter Pins from Low-Side MOSFETs for Three-Leg Current Sensing.
- Single-Grounded Power Supply for Built-in HVIC.
- Isolation Rating of 800 Vrms/min.

General Description

FSB43004A is a Motion SPM[®] 45 LV module that Fairchild developed based on low-loss PowerTrench[®] MOSFET technology as a compact motor drive inverter solution for small power applications supplied by low voltage battery.

Applications

Motion Control - Home Appliance / Industrial Motor.

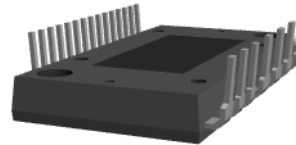

Figure 1. Packing Drawing
(Click to Activate 3D Content)

Package Marking and Ordering Information

Device	Device Marking	Package	Packing Type	Quantity
FSB43004A	FSB43004A	SPMAA-A22	Rail	14

Integrated Power Functions

- 40 V $R_{DS(ON)} = 2.1 \text{ m}\Omega$ (typ.) inverter for three-phase DC / AC power conversion (please refer to Figure 3)

Integrated Drive, Protection, and System Control Functions

- For inverter high-side MOSFETs: gate drive circuit, high-voltage isolated high-speed level shifting, Under-Voltage Lock-Out (UVLO) Protection.
- For inverter low-side MOSFETs: gate drive circuit, Under-Voltage Lock-Out (UVLO) Protection.
- Fault signaling: corresponding to UV (low-side supply).
- Input interface: active-HIGH interface, works with 3.3 / 5 V logic, Schmitt-trigger input

Pin Configuration

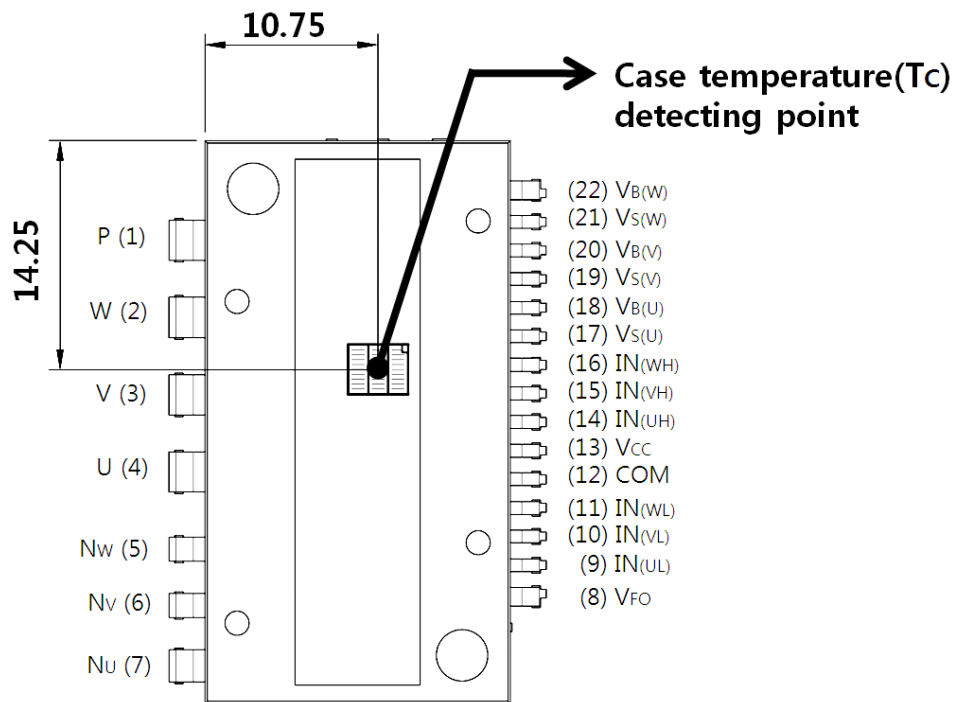

Pin Descriptions

Pin Number	Pin Name	Pin Description
1	P	Positive DC-Link Input
2	W	W Phase Output
3	V	V Phase Output
4	U	U Phase Output
5	N _W	Negative DC-Link Input
6	N _V	Negative DC-Link Input
7	N _U	Negative DC-Link Input
8	V _{FO}	Fault Output
9	IN _(UL)	PWM Input for Low-Side U Phase MOSFET Drive
10	IN _(VL)	PWM Input for Low-Side V Phase MOSFET Drive
11	IN _(WL)	PWM Input for Low-Side W Phase MOSFET Drive
12	COM	Common Supply Ground
13	V _{CC}	Common Supply Voltage for IC and Low-side MOSFET Drive
14	IN _(UH)	PWM Input for High-Side U Phase MOSFET Drive
15	IN _(VH)	PWM Input for High-Side V Phase MOSFET Drive
16	IN _(WH)	PWM Input for High-Side W Phase MOSFET Drive
17	V _{B(U)}	Supply Voltage for High-Side U Phase MOSFET Drive
18	V _{S(U)}	Supply Ground for High-Side U Phase MOSFET Drive
19	V _{B(V)}	Supply Voltage for High-Side V Phase MOSFET Drive
20	V _{S(V)}	Supply Ground for High-Side V Phase MOSFET Drive
21	V _{B(W)}	Supply Voltage for High-Side W Phase MOSFET Drive
22	V _{S(W)}	Supply Ground for High-Side W Phase MOSFET Drive

Internal Equivalent Circuit and Input/Output Pins

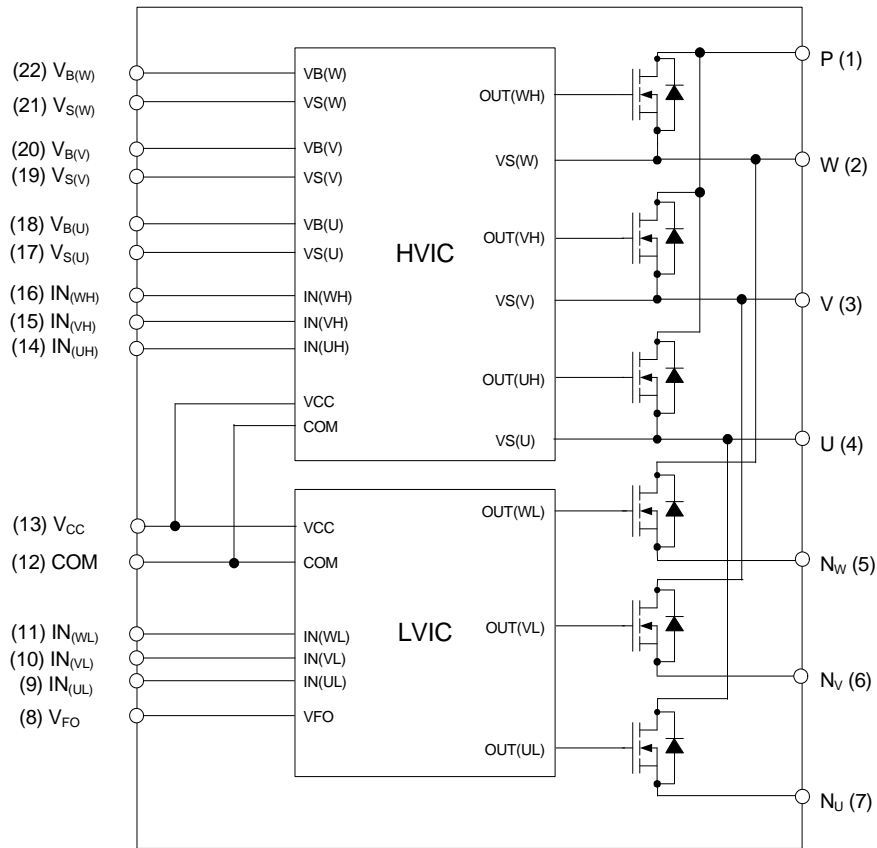

Figure 3. Internal Block Diagram

Absolute Maximum Ratings ($T_J = 25^\circ\text{C}$, unless otherwise specified.)

Inverter Part

Symbol	Parameter	Conditions	Rating	unit
V_{PN}	DC Link Input Voltage Drain-Source Voltage	Applied between P - $N_{(U)}$, $N_{(V)}$, $N_{(W)}$	40	V
$* \pm I_D$	Drain Current	$T_C = 25^\circ\text{C}$, $T_J \leq 150^\circ\text{C}$	71	A
		$T_C = 100^\circ\text{C}$, $T_J \leq 150^\circ\text{C}$	47	A
$* \pm I_{DP}$	Peak Drain Current	$T_C = 25^\circ\text{C}$, under 1ms Pulse Width, $T_J \leq 150^\circ\text{C}$	180	A
$* P_D$	Maximum Power Dissipation	$T_C = 25^\circ\text{C}$, per Chip, $T_J \leq 150^\circ\text{C}$	31	W
T_J	Operating Junction Temperature		-40 ~ 150	$^\circ\text{C}$

1st Note:

1. Rating value of marking "*" is calculation value or design factor.

Control Part

Symbol	Parameter	Conditions	Rating	unit
V_{CC}	Supply Voltage	Applied between V_{CC} - COM	20	V
V_{BS}	Supply Voltage	Applied between $V_{B(U)}$ - $V_{S(U)}$, $V_{B(V)}$ - $V_{S(V)}$, $V_{B(W)}$ - $V_{S(W)}$	20	V
V_{IN}	PWM Signal Voltage	Applied between $IN_{(UH)}$, $IN_{(VH)}$, $IN_{(WH)}$, $IN_{(UL)}$, $IN_{(VL)}$, $IN_{(WL)}$ - COM	-0.3 ~ $V_{CC}+0.3$	V
V_{FO}	Fault Output Supply Voltage	Applied between V_{FO} - COM	-0.3 ~ $V_{CC}+0.3$	V
I_{FO}	Fault Output Current	Sink Current at V_{FO} Pin	1	mA

Total System

Symbol	Parameter	Conditions	Rating	unit
T_{STG}	Storage Temperature		-40 ~ 150	$^\circ\text{C}$
V_{ISO}	Isolation Voltage	60 Hz, Sinusoidal, AC 1 Minute, Connect Pins to Ceramic Substrate	800	V_{rms}

Thermal Characteristics

Symbol	Parameter	Condition	Min.	Typ.	Max.	Unit
$R_{th(j-c)}$	Junction to Case Thermal Resistance	Inverter MOSFET part(per 1/6 module)	-	-	3.92	$^\circ\text{C/W}$

Electrical Characteristics (T_J = 25°C, unless otherwise specified.)

Inverter Part

Symbol	Parameter	Conditions	Min.	Typ.	Max.	Unit			
BV _{DSS}	Drain-Source Breakdown Voltage	V _{IN} =0 V, I _D =250 μA (2nd Notes 1)	40	-	-	V			
R _{DS(ON)}	Drain-Source ON Resistance	V _{CC} = V _{BS} = 15 V, V _{IN} = 5 V, I _D = 60 A	-	2.1	3.0	mΩ			
V _{SD}	Source-Drain Diode Forward Voltage	V _{CC} = V _{BS} = 15 V, V _{IN} = 0 V, I _{SD} = 60 A	-	0.8	-	V			
t _{ON}	Switching Characteristic	V _{PN} = 20 V, V _{CC} = V _{BS} = 15 V, I _D = 60 A, V _{IN} = 0 V ↔ 5 V, High side, Inductive Load (2nd Notes 2)	-	1750	-	ns			
t _{C(ON)}			-	900	-	ns			
t _{OFF}			-	2600	-	ns			
t _{C(OFF)}			-	800	-	ns			
t _{rr}			-	60	-	ns			
I _{rr}			-	3	-	A			
t _{ON}			V _{PN} = 20 V, V _{CC} = V _{BS} = 15 V, I _D = 60 A, V _{IN} = 0 V ↔ 5 V, Low side, Inductive Load (2nd Notes 2)	-	1900	-	ns		
t _{C(ON)}				-	850	-	ns		
t _{OFF}				-	2600	-	ns		
t _{C(OFF)}				-	850	-	ns		
t _{rr}				-	60	-	ns		
I _{rr}				-	6	-	A		
I _{DSS}				Drain-Source Leakage Current	V _{DS} = V _{DSS}	-	-	250	μA

2nd Notes:

- BV_{DSS} is the absolute maximum voltage rating between drain and source terminal of each MOSFET. V_{PN} should be sufficiently less than this value considering the effect of the stray inductance so that V_{DS} should not exceed BV_{DSS} in any case.
- t_{ON} and t_{OFF} include the propagation delay time of the internal drive IC. t_{C(ON)} and t_{C(OFF)} are the switching time of MOSFET itself under the given gate driving condition internally. For the detailed information, please see Figure 4.

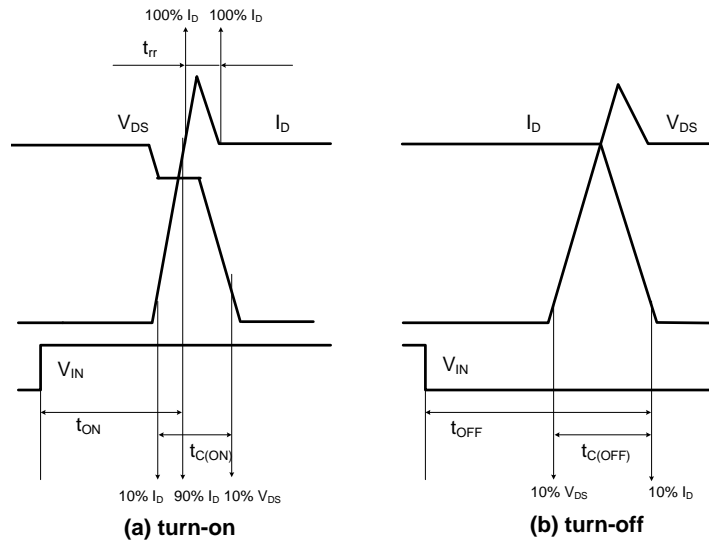

Figure 4. Switching Time Definition

Control Part

Symbol	Parameter	Conditions		Min.	Typ.	Max.	Unit
I_{QCC}	Quiescent V_{CC} Supply Current	$V_{CC} = 15\text{ V}$, $V_{IN} = 0\text{ V}$	$V_{CC} - \text{COM}$	-	-	2.75	mA
I_{QBS}	Quiescent V_{BS} Supply Current	$V_{BS} = 15\text{ V}$, $V_{IN} = 0\text{ V}$	$V_{B(U)} - V_{S(U)}$, $V_{B(V)} - V_{S(V)}$, $V_{B(W)} - V_{S(W)}$	-	-	0.3	mA
V_{FOH}	Fault Output Voltage	10 k Ω to 5 V Pull-up	Normal	4.5	-	-	V
V_{FOL}			Fault	-	-	0.5	V
UV_{CCD}	Supply Circuit Under-Voltage Protection	Detection Level		7.0	8.2	10.0	V
UV_{CCR}		Reset Level		8.0	9.4	11.0	V
UV_{BSD}		Detection Level		7.0	8.0	9.5	V
UV_{BSR}		Reset Level		8.0	9.0	10.5	V
t_{FOD}	Fault-Out Pulse Width			30	-	-	μs
$V_{IN(ON)}$	ON Threshold Voltage	Applied between $IN_{(UH)}$, $IN_{(VH)}$, $IN_{(WH)}$, $IN_{(UL)}$,		-	-	2.6	V
$V_{IN(OFF)}$	OFF Threshold Voltage	$IN_{(VL)}$, $IN_{(WL)} - \text{COM}$		0.8	-	-	V

Recommended Operating Conditions

Symbol	Parameter	Conditions	Value			Unit
			Min.	Typ.	Max.	
V_{PN}	Supply Voltage	Applied between P - $N_{(U)}$, $N_{(V)}$, $N_{(W)}$	-	20	-	V
V_{CC}	Control Supply Voltage	Applied between $V_{CC} - \text{COM}$	13.5	15	16.5	V
V_{BS}	Control Supply Voltage	Applied between $V_{B(U)} - V_{S(U)}$, $V_{B(V)} - V_{S(V)}$, $V_{B(W)} - V_{S(W)}$	13.0	15	18.5	V
dV_{CC}/dt , dV_{BS}/dt	Control Supply Variation		-1	-	1	V/ μs
V_{SEN}	Voltage for Current Sensing	Applied between N_U , N_V , $N_W - \text{COM}$ (Including surge voltage)	-4	-	4	V

Mechanical Characteristics and Ratings

Parameter	Conditions		Limits			Units
			Min.	Typ.	Max.	
Mounting Torque	Mounting Screw: - M3		0.51	0.62	0.72	N•m
Device Flatness		See Figure 5	-	-	120	μm
Weight			-	8.4	-	g

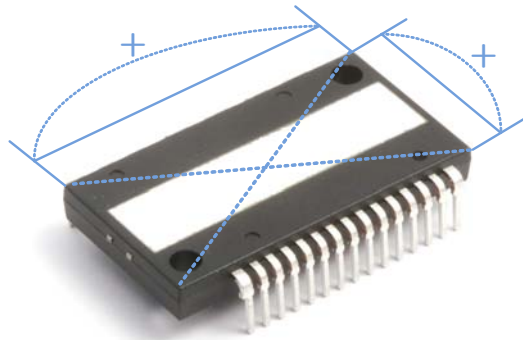

Figure 5. Flatness Measurement Position

Time Charts of Protective Function



- a1 : Control supply voltage rises: after the voltage rises UV_{CCR} , the circuits start to operate when the next input is applied.
- a2 : Normal operation: MOSFET ON and carrying current.
- a3 : Under-Voltage detection (UV_{CCD}).
- a4 : MOSFET OFF in spite of control input condition.
- a5 : Fault output operation starts.
- a6 : Under-Voltage reset (UV_{CCR}).
- a7 : Normal operation: MOSFET ON and carrying current.

Figure 6. Under-Voltage Protection (Low-side)



- b1 : Control supply voltage rises: after the voltage reaches UV_{BSR} , the circuits start to operate when the next input is applied.
- b2 : Normal operation: MOSFET ON and carrying current.
- b3 : Under-Voltage detection (UV_{BSD}).
- b4 : MOSFET OFF in spite of control input condition, but there is no fault output signal.
- b5 : Under-Voltage reset (UV_{BSR}).
- b6 : Normal operation: MOSFET ON and carrying current

Figure 7. Under-Voltage Protection (High-side)

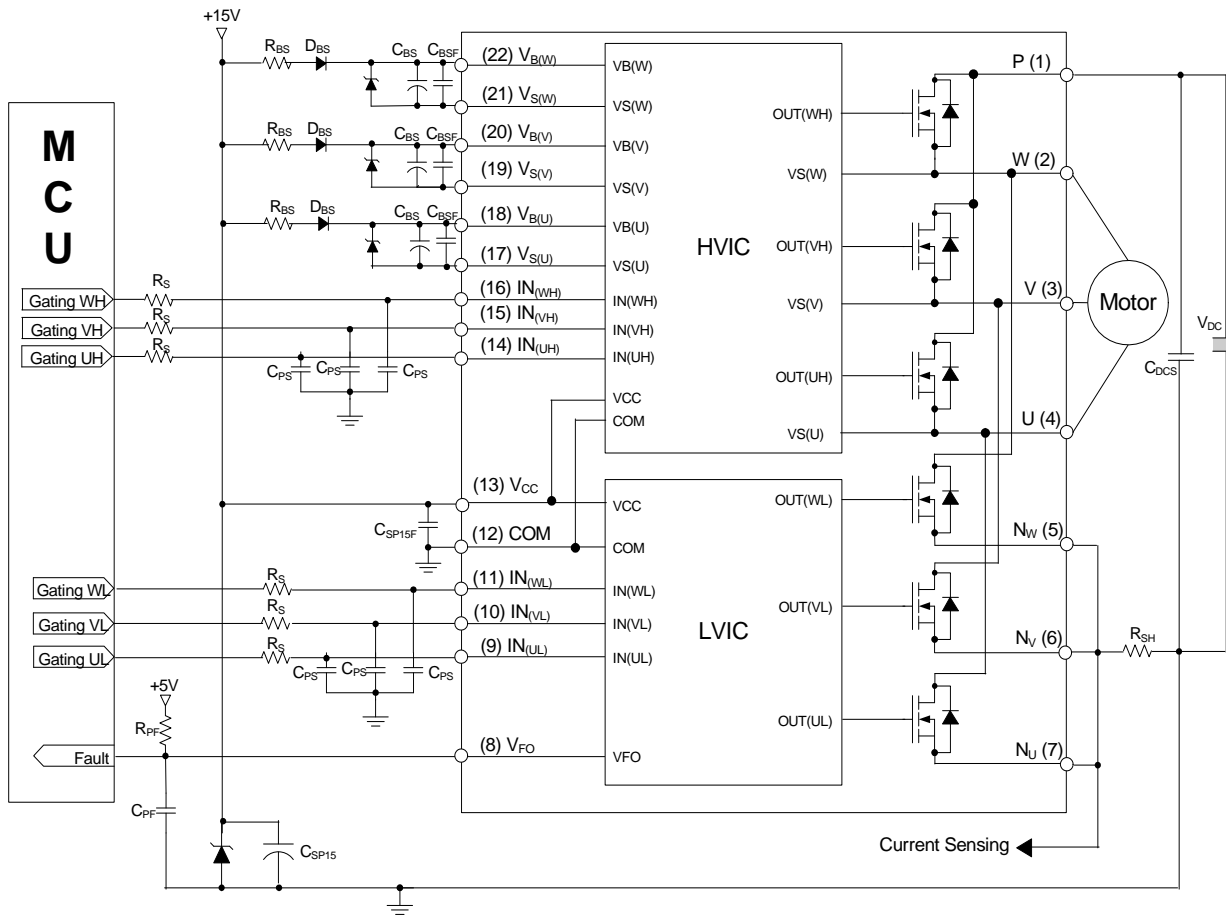

3rd Notes:

1. To avoid malfunction, the wiring of each input should be as short as possible. (less than 2-3 cm)
2. V_{FO} output is open drain type. This signal line should be pulled up to the positive side of the MCU or control power supply with a resistor that makes IFO up to 1 mA.
3. Input signal is High-Active type. There is a 5 k Ω resistor inside the IC to pull down each input signal line to GND. RC coupling circuits is recommended for the prevention of input signal oscillation. R_FC_F constant should be selected in the range 50-150ns. (Recommended R_S=100 Ω , C_{PS}=1 nF)
4. Each capacitors should be mounted as close to the SPM® pins as possible.
5. Relays are used at almost every systems of electrical equipment of home appliances. In these cases, there should be sufficient distance between the CPU and the relays.
6. The zener diode should be adopted for the protection of ICs from the surge destruction between each pair of control supply terminals. (Recommended zener diode=24 / 1 W)

Figure 8. Typical Application Circuit

Detailed Package Outline Drawings

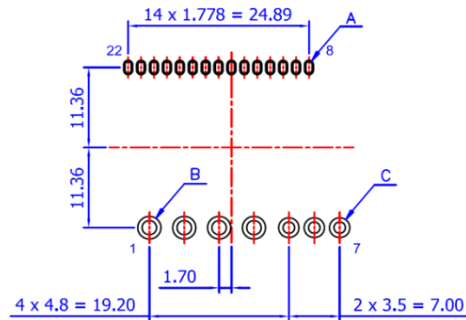
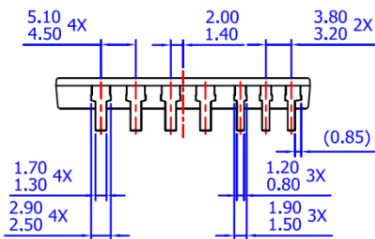
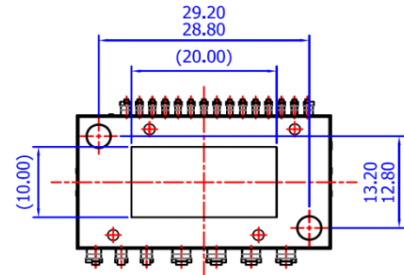
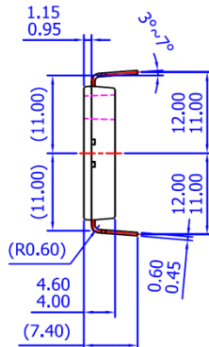
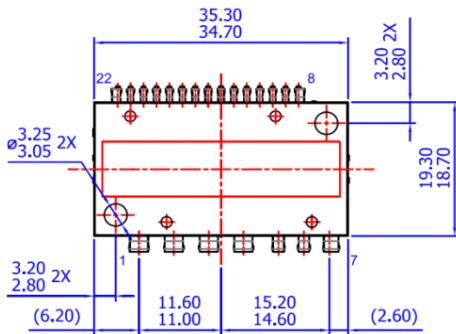
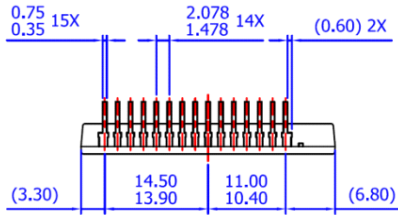

- NOTES: UNLESS OTHERWISE SPECIFIED
 A) THIS PACKAGE DOES NOT COMPLY TO ANY CURRENT PACKAGING STANDARD
 B) ALL DIMENSIONS ARE IN MILLIMETERS
 C) DIMENSIONS ARE EXCLUSIVE OF BURRS, MOLD FLASH, AND TIE BAR EXTRUSIONS
 D) () IS REFERENCE
 E) [] IS ASS'Y QUALITY
 F) DRAWING FILENAME: MOD22AAREV1.0
 G) FAIRCHILD SEMICONDUCTOR

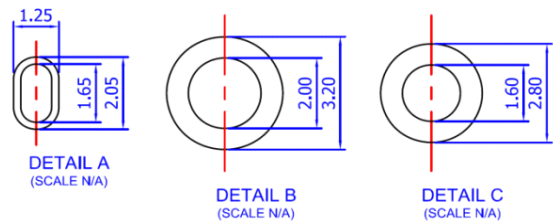

LAND PATTERN RECOMMENDATIONS

Package drawings are provided as a service to customers considering Fairchild components. Drawings may change in any manner without notice. Please note the revision and/or data on the drawing and contact a FairchildSemiconductor representative to verify or obtain the most recent revision. Package specifications do not expand the terms of Fairchild's worldwide therm and conditions, specifically the the warranty therein, which covers Fairchild products.





Always visit Fairchild Semiconductor's online packaging area for the most recent package drawings:

<http://www.fairchildsemi.com/dwg/MO/MOD22AA.pdf>



TRADEMARKS

The following includes registered and unregistered trademarks and service marks, owned by Fairchild Semiconductor and/or its global subsidiaries, and is not intended to be an exhaustive list of all such trademarks.

AccuPower™	F-PFST™	OPTOPLANAR®	
AttitudeEngine™	FRFET®		TinyBoost®
Awinda®	Global Power Resource™	Power Supply WebDesigner™	TinyBuck®
AX-CAP®*	GreenBridge™	PowerTrench®	TinyCalc™
BitSiC™	Green FPS™	PowerXS™	TinyLogic®
Build it Now™	Green FPS™ e-Series™	Programmable Active Droop™	TINYOPTO™
CorePLUS™	Gmax™	QFET®	TinyPower™
CorePOWER™	GTO™	QS™	TinyPWM™
CROSSVOLT™	IntelliMAX™	Quiet Series™	TinyWire™
CTL™	ISOPLANAR™	RapidConfigure™	TranSiC™
Current Transfer Logic™	Making Small Speakers Sound Louder and Better™		TriFault Detect™
DEUXPEED®	MegaBuck™	Saving our world, 1mW/W/kW at a time™	TRUECURRENT®*
Dual Cool™	MICROCOUPLER™	SignalWise™	µSerDes™
EcoSPARK®	MicroFET™	SmartMax™	
EfficientMax™	MicroPak™	SMART START™	UHC®
ESBC™	MicroPak2™	Solutions for Your Success™	Ultra FRFET™
	MillerDrive™	SPM®	UniFET™
Fairchild®	MotionMax™	STEALTH™	VCX™
Fairchild Semiconductor®	MotionGrid®	SuperFET®	VisualMax™
FACT Quiet Series™	MTI®	SuperSOT™-3	VoltagePlus™
FACT®	MTX®	SuperSOT™-6	XS™
FAST®	MVN®	SuperSOT™-8	Xsens™
FastvCore™	mWSaver®	SupreMOS®	仙童™
FETBench™	OptoHit™	SyncFET™	
FPS™	OPTOLOGIC®	Sync-Lock™	

* Trademarks of System General Corporation, used under license by Fairchild Semiconductor.

DISCLAIMER

FAIRCHILD SEMICONDUCTOR RESERVES THE RIGHT TO MAKE CHANGES WITHOUT FURTHER NOTICE TO ANY PRODUCTS HEREIN TO IMPROVE RELIABILITY, FUNCTION, OR DESIGN. TO OBTAIN THE LATEST, MOST UP-TO-DATE DATASHEET AND PRODUCT INFORMATION, VISIT OUR WEBSITE AT [HTTP://WWW.FAIRCHILDSEMI.COM](http://www.fairchildsemi.com). FAIRCHILD DOES NOT ASSUME ANY LIABILITY ARISING OUT OF THE APPLICATION OR USE OF ANY PRODUCT OR CIRCUIT DESCRIBED HEREIN; NEITHER DOES IT CONVEY ANY LICENSE UNDER ITS PATENT RIGHTS, NOR THE RIGHTS OF OTHERS. THESE SPECIFICATIONS DO NOT EXPAND THE TERMS OF FAIRCHILD'S WORLDWIDE TERMS AND CONDITIONS, SPECIFICALLY THE WARRANTY THEREIN, WHICH COVERS THESE PRODUCTS.

AUTHORIZED USE

Unless otherwise specified in this data sheet, this product is a standard commercial product and is not intended for use in applications that require extraordinary levels of quality and reliability. This product may not be used in the following applications, unless specifically approved in writing by a Fairchild officer: (1) automotive or other transportation, (2) military/aerospace, (3) any safety critical application – including life critical medical equipment – where the failure of the Fairchild product reasonably be expected to result in personal injury, death or property damage. Customer's use of this product is subject to agreement of this Authorized Use policy. In the event of an unauthorized use of Fairchild's product, Fairchild accepts no liability in the event of product failure. In other respects, this product shall be subject to Fairchild's Worldwide Terms and Conditions of Sale, unless a separate agreement has been signed by both Parties.

ANTI-COUNTERFEITING POLICY

Fairchild Semiconductor Corporation's Anti-Counterfeiting Policy. Fairchild's Anti-Counterfeiting Policy is also stated on our external website, www.fairchildsemi.com, under Terms of Use

Counterfeiting of semiconductor parts is a growing problem in the industry. All manufacturers of semiconductor products are experiencing counterfeiting of their parts. Customers who inadvertently purchase counterfeit parts experience many problems such as loss of brand reputation, substandard performance, failed applications, and increased cost of production and manufacturing delays. Fairchild is taking strong measures to protect ourselves and our customers from the proliferation of counterfeit parts. Fairchild strongly encourages customers to purchase Fairchild parts either directly from Fairchild or from Authorized Fairchild Distributors who are listed by country on our web page cited above. Products customers buy either from Fairchild directly or from Authorized Fairchild Distributors are genuine parts, have full traceability, meet Fairchild's quality standards for handling and storage and provide access to Fairchild's full range of up-to-date technical and product information. Fairchild and our Authorized Distributors will stand behind all warranties and will appropriately address any warranty issues that may arise. Fairchild will not provide any warranty coverage or other assistance for parts bought from Unauthorized Sources. Fairchild is committed to combat this global problem and encourage our customers to do their part in stopping this practice by buying direct or from authorized distributors.

PRODUCT STATUS DEFINITIONS

Definition of Terms

Datasheet Identification	Product Status	Definition
Advance Information	Formative / In Design	Datasheet contains the design specifications for product development. Specifications may change in any manner without notice.
Preliminary	First Production	Datasheet contains preliminary data; supplementary data will be published at a later date. Fairchild Semiconductor reserves the right to make changes at any time without notice to improve design.
No Identification Needed	Full Production	Datasheet contains final specifications. Fairchild Semiconductor reserves the right to make changes at any time without notice to improve the design.
Obsolete	Not In Production	Datasheet contains specifications on a product that is discontinued by Fairchild Semiconductor. The datasheet is for reference information only.

Rev. 175

ON Semiconductor and  are trademarks of Semiconductor Components Industries, LLC dba ON Semiconductor or its subsidiaries in the United States and/or other countries. ON Semiconductor owns the rights to a number of patents, trademarks, copyrights, trade secrets, and other intellectual property. A listing of ON Semiconductor's product/patent coverage may be accessed at www.onsemi.com/site/pdf/Patent-Marking.pdf. ON Semiconductor reserves the right to make changes without further notice to any products herein. ON Semiconductor makes no warranty, representation or guarantee regarding the suitability of its products for any particular purpose, nor does ON Semiconductor assume any liability arising out of the application or use of any product or circuit, and specifically disclaims any and all liability, including without limitation special, consequential or incidental damages. Buyer is responsible for its products and applications using ON Semiconductor products, including compliance with all laws, regulations and safety requirements or standards, regardless of any support or applications information provided by ON Semiconductor. "Typical" parameters which may be provided in ON Semiconductor data sheets and/or specifications can and do vary in different applications and actual performance may vary over time. All operating parameters, including "Typicals" must be validated for each customer application by customer's technical experts. ON Semiconductor does not convey any license under its patent rights nor the rights of others. ON Semiconductor products are not designed, intended, or authorized for use as a critical component in life support systems or any FDA Class 3 medical devices or medical devices with a same or similar classification in a foreign jurisdiction or any devices intended for implantation in the human body. Should Buyer purchase or use ON Semiconductor products for any such unintended or unauthorized application, Buyer shall indemnify and hold ON Semiconductor and its officers, employees, subsidiaries, affiliates, and distributors harmless against all claims, costs, damages, and expenses, and reasonable attorney fees arising out of, directly or indirectly, any claim of personal injury or death associated with such unintended or unauthorized use, even if such claim alleges that ON Semiconductor was negligent regarding the design or manufacture of the part. ON Semiconductor is an Equal Opportunity/Affirmative Action Employer. This literature is subject to all applicable copyright laws and is not for resale in any manner.

PUBLICATION ORDERING INFORMATION

LITERATURE FULFILLMENT:

Literature Distribution Center for ON Semiconductor
19521 E. 32nd Pkwy, Aurora, Colorado 80011 USA
Phone: 303-675-2175 or 800-344-3860 Toll Free USA/Canada
Fax: 303-675-2176 or 800-344-3867 Toll Free USA/Canada
Email: orderlit@onsemi.com

N. American Technical Support: 800-282-9855 Toll Free
USA/Canada
Europe, Middle East and Africa Technical Support:
Phone: 421 33 790 2910
Japan Customer Focus Center
Phone: 81-3-5817-1050

ON Semiconductor Website: www.onsemi.com
Order Literature: <http://www.onsemi.com/orderlit>
For additional information, please contact your local
Sales Representative