



# Current Monitor and Accumulator with Integrated Sense Resistor

DS2741

## General Description

The DS2741 current monitor/accumulator is a complete current-sensing, measuring, and accumulation device tailored for cost-sensitive, battery-powered applications in a small 3mm x 3mm TDFN package. As a result, the DS2741 is a key component in battery-charge control and remaining capacity-estimation applications.

Through its I<sup>2</sup>C interface, the DS2741 gives the host system access to current measurement and accumulation registers. The 7-bit slave address is factory programmable, allowing up to 128 devices to be individually addressed by the host system.

## Applications

Cell Phones  
PDAs  
Battery Monitor/Rechargers

## Ordering Information

PART	TEMP RANGE	PIN-PACKAGE
DS2741N+	-20°C to +70°C	14 TDFN-EP*
DS2741N+T	-20°C to +70°C	14 TDFN-EP*

+Denotes a lead(Pb)-free/RoHS-compliant package.

T = Tape and reel.

\*EP = Exposed pad.

## Typical Operating Circuit

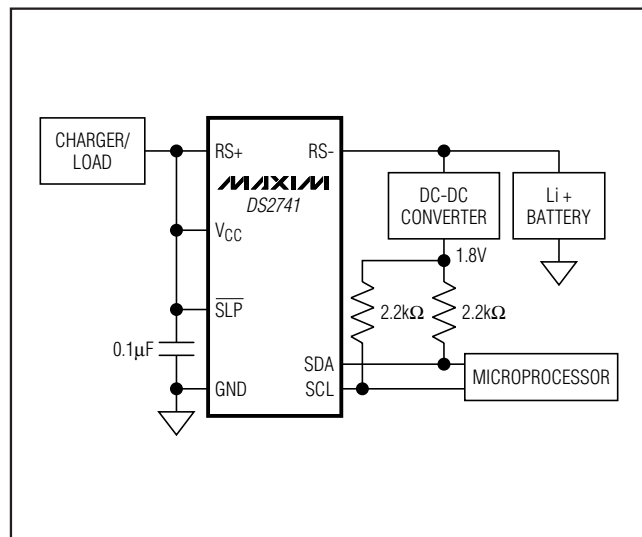

## Features

- ◆ Complete, Low-Cost, Integrated Current-Sensing and Accumulation Solution with Serial Digital Output
- ◆ On-Board 38mΩ Sense Resistor
- ◆ Current Measurement:
  - Signed 10-Bit Bidirectional Measurement
  - ±2.5A Dynamic Range
  - 1% Error at +25°C
  - 2% Error Over Temperature
- ◆ Current Accumulation:
  - 0.247mAh LSB
  - ±8.1Ahrs Full-Scale Range
- ◆ Industry-Standard I<sup>2</sup>C Interface with Factory-Programmable Slave Address
- ◆ 2.5V to 4.5V Single-Supply Operation
- ◆ Low-Power Consumption:
  - Active Current: 60µA (typ)
  - Sleep Current: 1µA (typ)
- ◆ -20°C to +70°C Operating Range
- ◆ 14-Pin TDFN (3mm x 3mm x 0.8mm)

## Pin Configuration

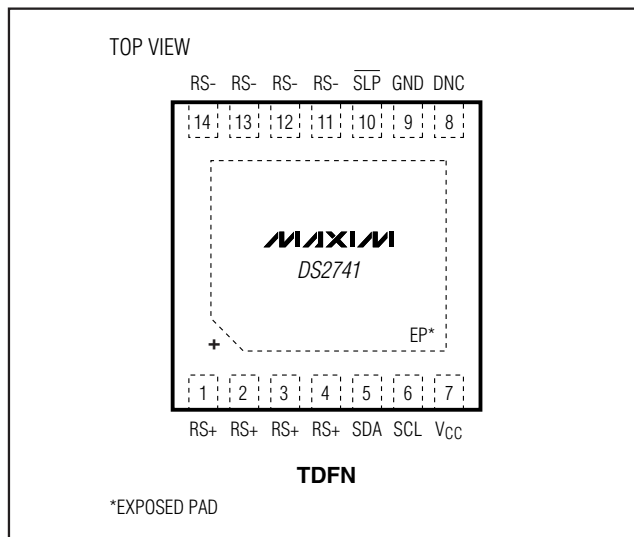

# Current Monitor and Accumulator with Integrated Sense Resistor

## ABSOLUTE MAXIMUM RATINGS

Voltage Range on  $V_{CC}$  Relative to GND .....-0.5V to +6.0V  
 Voltage Range on SDA, SCL,  
 RS+, RS-,  $\overline{SLP}$  Relative to GND.....-0.5V to ( $V_{CC} + 0.5V$ ), not to  
 exceed +6.0V  
 Continuous Internal Sense Resistor Current ..... $\pm 2.7A$

Pulsed Internal Sense Resistor  
 Current ..... $\pm 10A$  for <100 $\mu s$ , <1000 pulses  
 Operating Temperature Range .....-20°C to +70°C  
 Storage Temperature Range .....-55°C to +125°C  
 Soldering Temperature.....Refer to the IPC/JEDEC  
 J-STD-020 Specification.

Stresses beyond those listed under "Absolute Maximum Ratings" may cause permanent damage to the device. These are stress ratings only, and functional operation of the device at these or any other conditions beyond those indicated in the operational sections of the specifications is not implied. Exposure to absolute maximum rating conditions for extended periods may affect device reliability.

## RECOMMENDED OPERATING CONDITIONS

( $T_A = -20^\circ C$  to  $+70^\circ C$ .)

PARAMETER	SYMBOL	CONDITIONS	MIN	TYP	MAX	UNITS
Supply Voltage	$V_{CC}$	(Note 1)	2.5		4.5	V
Input Logic-High: SCL, SDA	$V_{IH}$		1.5			V
Input Logic-Low: SCL, SDA	$V_{IL}$				0.4	V
Input Logic-High: $\overline{SLP}$	$V_{IH}$		0.7 x $V_{CC}$			V
Input Logic-Low: $\overline{SLP}$	$V_{IL}$				0.3 x $V_{CC}$	V
Power-Up Ramp Time from 0V to $V_{CCMIN}$	$t_{RAMP}$				25	ms

## DC ELECTRICAL CHARACTERISTICS

( $2.5V \leq V_{CC} \leq 4.5V$ ,  $T_A = -20^\circ C$  to  $+70^\circ C$ .)

PARAMETER	SYMBOL	CONDITIONS	MIN	TYP	MAX	UNITS
Active Current	$I_{ACTIVE}$	$\overline{SLP} = SCL = SDA = V_{CC}$		60	90	$\mu A$
Sleep-Mode Current	$I_{SLEEP}$	$\overline{SLP} = 0V$		1	2	$\mu A$
Output Logic-Low: SDA	$V_{OL}$	$I_{OL} = 4mA$ (Note 1)	0.4			V
Internal Current-Sense Resistor Value	$R_{SNS}$	+25°C		38	45	$m\Omega$
Current Resolution	$I_{LSB}$			2.64		mA
Current Full-Scale Magnitude	$I_{FS}$	(Note 2)	2.54	2.7		A
Current-Sense Accuracy at +25°C	ATL	$I_{SENSE}$ at 1.5A		$\pm 1$	$\pm 3$	%
Current-Sense Accuracy from 0°C to +70°C	ATL	$I_{SENSE}$ at 1.5A		$\pm 2$	$\pm 5$	%
Current Sampling Rate	$t_{CSR}$	(Note 3)		200		$\mu s$
Accumulator Resolution	QCA			0.247		mAh
Internal Time-Base Accuracy	$t_{ERR1}$	(Note 4)		$\pm 1$	$\pm 3$	%
	$t_{ERR2}$	(Note 4)			$\pm 6.5$	
Current-Sense Offset		Measured with RS+ and RS- shorted	-20		+20	mA

# Current Monitor and Accumulator with Integrated Sense Resistor

DS2741

## TEMPERATURE SENSOR CHARACTERISTICS

( $V_{CC} = +2.5V$  to  $+4.5V$ ,  $T_A = -20^{\circ}C$  to  $+70^{\circ}C$ , unless otherwise noted.)

PARAMETER	SYMBOL	CONDITIONS	MIN	TYP	MAX	UNITS
Temperature Error					±5	°C

## AC ELECTRICAL CHARACTERISTICS: I<sup>2</sup>C INTERFACE

( $2.5V \leq V_{CC} \leq 4.5V$ ,  $T_A = -20^{\circ}C$  to  $+70^{\circ}C$ , timing referenced to  $V_{IL(MAX)}$  and  $V_{IH(MIN)}$ . See Figure 4.)

PARAMETER	SYMBOL	CONDITIONS	MIN	TYP	MAX	UNITS
SCL Clock Frequency	f <sub>SCL</sub>	(Note 5)	0		400	kHz
Bus Free Time Between STOP and START Conditions	t <sub>BUF</sub>		1.3			μs
Hold Time (Repeated) START Condition	t <sub>HD:STA</sub>		0.6			μs
Low Period of SCL	t <sub>LOW</sub>		1.3			μs
High Period of SCL	t <sub>HIGH</sub>		0.6			μs
Data Hold Time	t <sub>HD:DAT</sub>		0		0.9	μs
Data Setup Time	t <sub>SU:DAT</sub>		100			ns
START Setup Time	t <sub>SU:STA</sub>		0.6			μs
SDA and SCL Rise Time	t <sub>R</sub>	(Note 6)	20 + 0.1C <sub>B</sub>		300	ns
SDA and SCL Fall Time	t <sub>F</sub>	(Note 6)	20 + 0.1C <sub>B</sub>		300	ns
STOP Setup Time	t <sub>SU:STO</sub>		0.6			μs
SDA and SCL Capacitive Loading	C <sub>B</sub>	(Note 6)			400	pF

**Note 1:** All voltages are referenced to GND. Currents entering the IC are specified positive and currents exiting the IC are negative.

**Note 2:** Compensation of the internal sense resistor value for initial tolerance and temperature coefficient of  $-20^{\circ}C$  to  $+70^{\circ}C$  can reduce the maximum reportable magnitude to 2.5A.

**Note 3:** Current sampling ceases for 2.5ms every 144ms to allow the ADC to measure temperature.

**Note 4:** Typical value for t<sub>ERR1</sub> is specified at 3.6V and  $+25^{\circ}C$ , max value is specified for  $0^{\circ}C$  to  $+50^{\circ}C$ . Max value for t<sub>ERR2</sub> is specified for  $-20^{\circ}C$  to  $+70^{\circ}C$ .

**Note 5:** Interface timing shown is for fast-mode (400kHz) operation. This device is also backward compatible with standard-mode I<sup>2</sup>C timing.

**Note 6:** C<sub>B</sub>—Total capacitance of one bus line in pF; timing referenced to  $0.1 \times V_{CC}$  and  $0.9 \times V_{CC}$ .

# Current Monitor and Accumulator with Integrated Sense Resistor

## Typical Operating Characteristics

( $V_{CC} = +2.5V$  to  $+4.5V$ ,  $T_A = -20^\circ C$  to  $+70^\circ C$ , unless otherwise noted.)

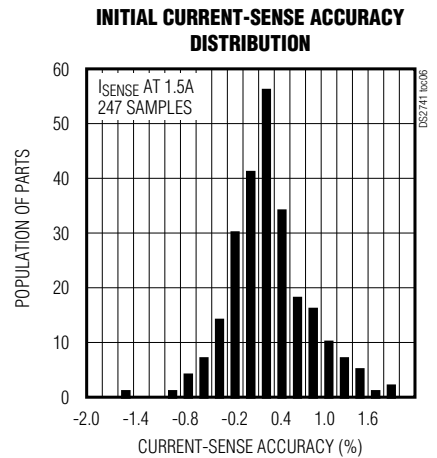
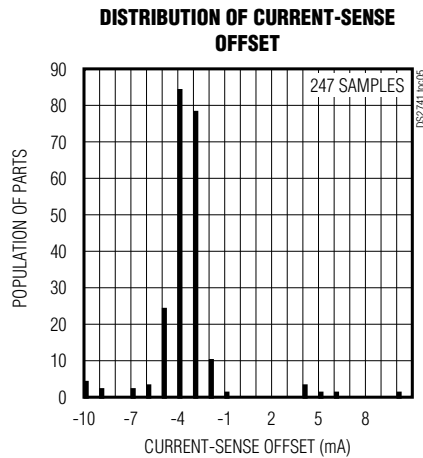
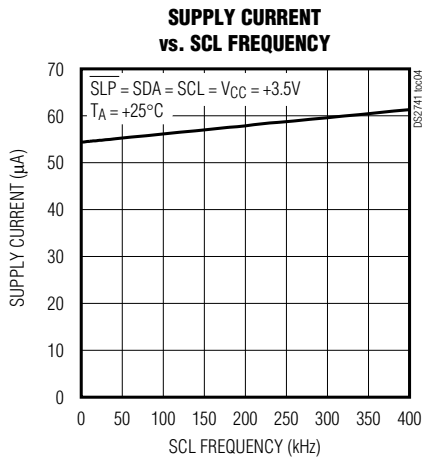
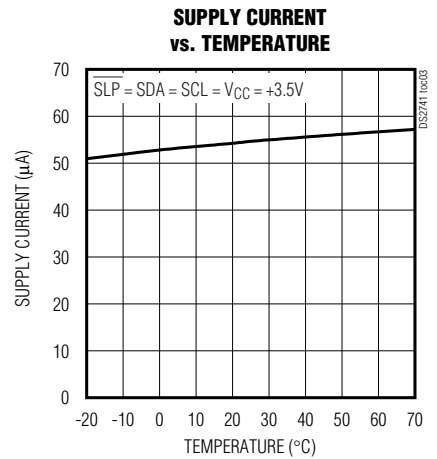
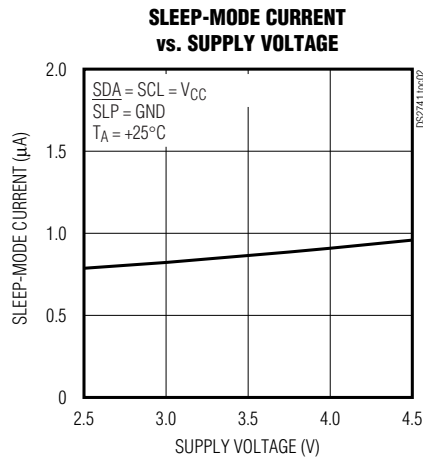
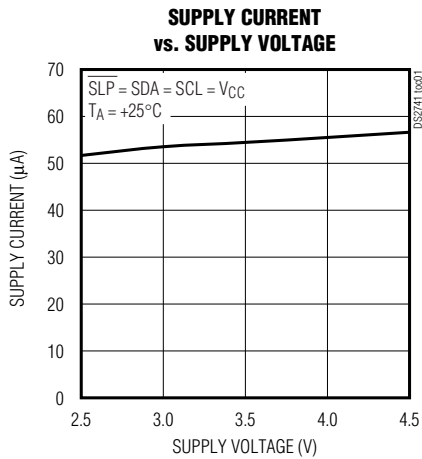

# Current Monitor and Accumulator with Integrated Sense Resistor

DS2741

## Pin Description

PIN	NAME	FUNCTION
1–4	RS+	Sense Resistor High Side. Connection to high side of internal 38mΩ sense resistor. All RS+ pins must be connected together.
5	SDA	Serial Data Input/Output. SDA is the input/output pin for the I <sup>2</sup> C serial interface. The SDA pin is an open-drain output and requires an external pullup resistor.
6	SCL	Serial Clock Input. SCL is used to synchronize data movement on the I <sup>2</sup> C serial interface.
7	VCC	Supply Voltage. Power-supply input.
8	DNC	Do Not Connect
9	GND	Ground
10	$\overline{\text{SLP}}$	Sleep Input (Active Low). When taken low, the DS2741 is placed in a low-power sleep state where all internal circuitry including the I <sup>2</sup> C bus is disabled. Toggling the $\overline{\text{SLP}}$ pin low and then back high resets the device and the I <sup>2</sup> C bus logic.
11–14	RS-	Sense Resistor Low Side. Connection to low side of internal 38mΩ sense resistor. All RS- pins must be connected together.
—	EP	Exposed Pad. Can be left floating.

## Block Diagram

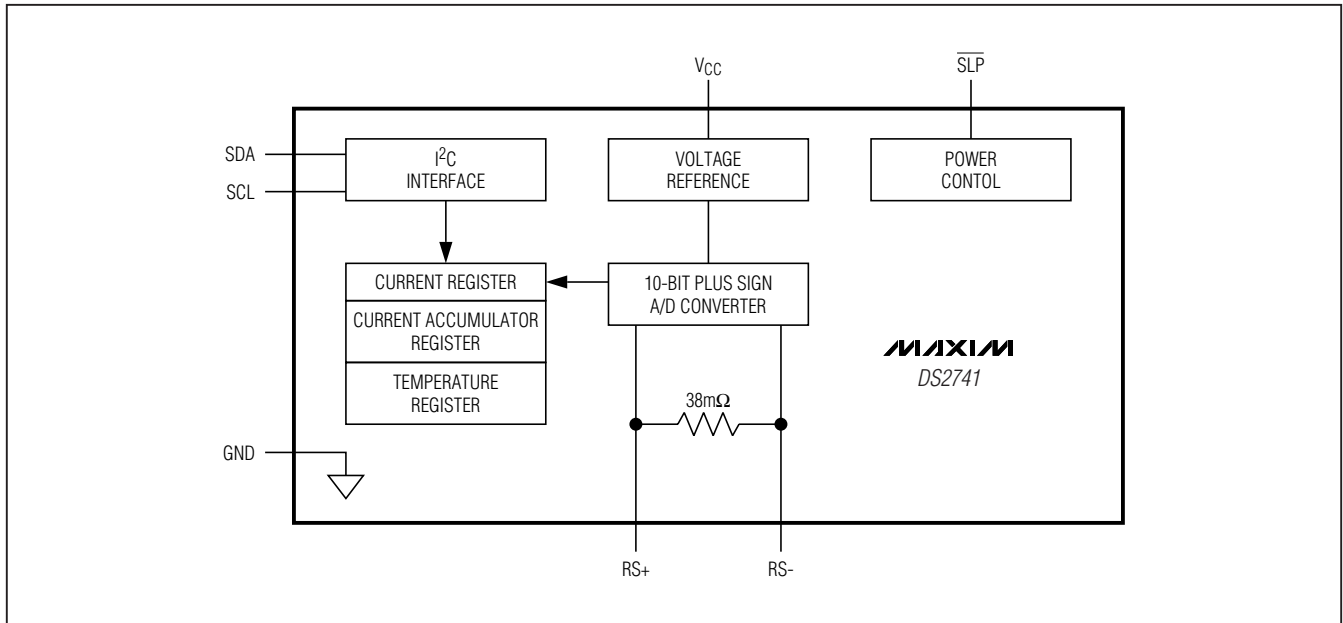

# Current Monitor and Accumulator with Integrated Sense Resistor

## Detailed Description

The DS2741 is a small, low-cost, current-sensing and accumulation IC that is intended for current-monitoring applications. The differential voltage measured across the on-chip  $38\text{m}\Omega$  sense resistor is digitized by an internal ADC that provides an accurately scaled digital signed 10-bit value that represents bidirectional current up to  $\pm 2.5\text{A}$ . The measured current result is reported in an internal SRAM register that can be read using the I<sup>2</sup>C interface. After each current measurement, the signed result value is added to an accumulator in order to maintain a signed accumulated current value with a  $0.247\text{mAh}$  LSB and a full-scale range of  $\pm 8.1\text{Ahrs}$ . The device can be placed into a low-power sleep mode when current measurements are not needed.

## Power Modes

The DS2741 has two power modes: active and sleep. While in active mode, the DS2741 continually measures and accumulates current and provides data to the host system through its I<sup>2</sup>C interface. In sleep mode, the DS2741 ceases these activities. The DS2741 enters sleep mode whenever an active-low signal is applied to the  $\overline{\text{SLP}}$  pin and remains in sleep as long as the  $\overline{\text{SLP}}$  pin is held low. Active mode resumes when the  $\overline{\text{SLP}}$  pin is returned to a logic-high level. The  $\overline{\text{SLP}}$  pin resets the Current and Temperature registers, but not the Current Accumulator register.

## Current Measurement

In active mode, the DS2741 continually measures the current flow into and out of the battery by measuring the voltage drop across the internally integrated  $38\text{m}\Omega$  current-sense resistor. The DS2741 considers the voltage difference between pins RS+ and RS- ( $V_{\text{RS}} = V_{\text{RS}+} - V_{\text{RS}-}$ )

to be the filtered voltage drop across the sense resistor. A positive  $V_{\text{RS}}$  value indicates current is flowing into the battery (charging), while a negative  $V_{\text{RS}}$  value indicates current is flowing out of the battery (discharging).

$V_{\text{RS}}$  is measured with a signed resolution of 10 bits. The current register is updated in two's-complement format every 22.7ms with an average of eight readings. Current measurements outside the register range are reported at the range limit. Figure 1 shows the format of the current register.

The DS2741 maintains the current register in units of amps, with a resolution of 2.64mA and full-scale range of no less than  $\pm 2.5\text{A}$ . The DS2741 automatically compensates for internal sense resistor process variations and temperature effects when reporting current.

## Current Accumulator

The current accumulator facilitates remaining capacity estimation by tracking the net current flow into and out of the battery. Current flow into the battery increments the current accumulator, while current flow out of the battery decrements it. The DS2741 maintains the current accumulator 0.247mAh resolution and full-scale value of  $\pm 8.1\text{Ahrs}$  range. Data is maintained in the current accumulator in two's-complement format. Figure 2 shows the format of the current accumulator. The current accumulator is a read/write register that can be altered by the host system as needed. The Current Accumulator register is not reset when the DS2741 is in sleep mode.

## Temperature Measurement

The on-board temperature sensor measures temperatures from  $+127^{\circ}\text{C}$  to  $-128^{\circ}\text{C}$ . The LSB of register 14h has a  $1^{\circ}\text{C}$  bit weight. See Figure 3 for the temperature register's two's-complement format.

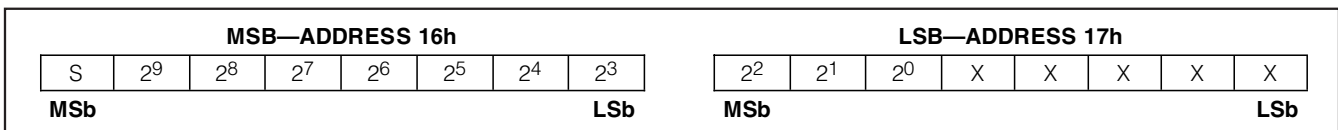

Figure 1. Current Register Format



Figure 2. Current Accumulator Register Format

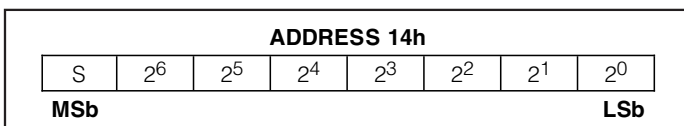

Figure 3. Temperature Register Format

# Current Monitor and Accumulator with Integrated Sense Resistor

## Registers

The DS2741 has 2-byte registers for current measurement and accumulation. When the MSB of a 2-byte register is read, both the MSB and LSB are latched and held for the duration of the read data command to prevent updates during the read and ensure synchronization between the two register bytes. For consistent results, always read the MSB and the LSB of a 2-byte register during the same read data command sequence.

**Table 1. Register Map**

ADDRESS (HEX)	DESCRIPTION	READ/WRITE
00h to 0Fh	Reserved	—
10h and 11h	Current Accumulator Register	R/W
12h and 13h	Reserved	—
14h	Temperature Register	R
15h	Reserved	—
16h and 17h	Current Register	R
18h to FFh	Reserved	—

## I<sup>2</sup>C Bus Interface

### I<sup>2</sup>C Definitions

The following terminology is commonly used to describe I<sup>2</sup>C data transfers.

**Master Device:** The master device controls the slave devices on the bus. The master device generates SCL clock pulses and START and STOP conditions.

**Slave Devices:** Slave devices send and receive data at the master's request.

**Bus Idle or Not Busy:** Time between STOP and START conditions when both SDA and SCL are inactive and in their logic-high states. When the bus is idle it often initiates a low-power mode for slave devices.

**START Condition:** A START condition is generated by the master to initiate a new data transfer with a slave. Transitioning SDA from high to low, while SCL remains high, generates a START condition. See Figure 4 for applicable timing.

**STOP Condition:** A STOP condition is generated by the master to end a data transfer with a slave. Transitioning SDA from low to high, while SCL remains high, generates a STOP condition. See Figure 4 for applicable timing.

**Repeated START Condition:** The master can use a repeated START condition at the end of one data transfer to indicate that it will immediately initiate a new data transfer following the current one. Repeated STARTs are commonly used during read operations to identify a specific memory address to begin a data transfer. A repeated START condition is issued identically to a normal START condition. See Figure 4 for applicable timing.

**Bit Write:** Transitions of SDA must occur during the low state of SCL. The data on SDA must remain valid and unchanged during the entire high pulse of SCL plus the setup and hold-time requirements (see Figure 4). Data is shifted into the device during the rising edge of the SCL.

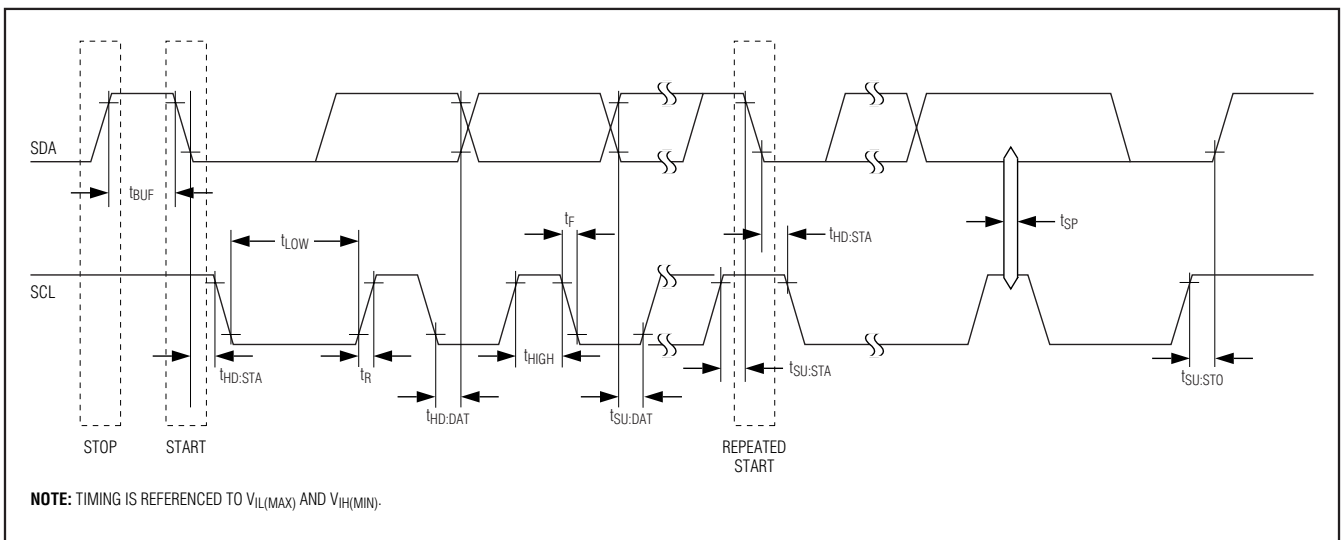

Figure 4. I<sup>2</sup>C Timing Diagram



# Current Monitor and Accumulator with Integrated Sense Resistor

**Bit Read:** At the end a write operation, the master must release the SDA bus line for the proper amount of setup time (Figure 4) before the next rising edge of SCL during a bit read. The device shifts out each bit of data on SDA at the falling edge of the previous SCL pulse, and the data bit is valid at the rising edge of the current SCL pulse. Remember that the master generates all SCL clock pulses, including when it is reading bits from the slave.

**Acknowledgement (ACK and NACK):** An acknowledgement (ACK) or not acknowledge (NACK) is always the 9th bit transmitted during a byte transfer. The device receiving data (the master during a read or the slave during a write operation) performs an ACK by transmitting a zero during the 9th bit. A device performs a NACK by transmitting a one during the 9th bit. Timing for the ACK and NACK is identical to all other bit writes (see Figure 4). An ACK is the acknowledgment that the device is properly receiving data. A NACK is used to terminate a read sequence or as an indication that the device is not receiving data.

**Byte Write:** A byte write consists of 8 bits of information transferred from the master to the slave (most significant bit first) plus a 1-bit acknowledgement from the slave to the master. The 8 bits transmitted by the master are done according to the bit-write definition and the acknowledgement is read using the bit-read definition.

**Byte Read:** A byte read is an 8-bit information transfer from the slave to the master plus a 1-bit ACK or NACK from the master to the slave. The 8 bits of information that are transferred (most significant bit first) from the slave to the master are read by the master using the bit-read definition, and the master transmits an ACK using the bit-write definition to receive additional data bytes. The master must NACK the last byte read to terminate communication so that the slave returns control of SDA to the master.

**Slave Address Byte:** Each slave on the I<sup>2</sup>C bus responds to a slave addressing byte sent immediately following a START condition. The slave address byte (Figure 5) contains the slave address in the most significant 7 bits and the R/W bit in the least significant bit.

The DS2741's default factory programmed 7-bit slave address is 0110100b (binary) or 68h (hex). By writing the correct slave address with R/W = 0, the master indicates it will write data to the slave. If R/W = 1, the master reads data from the slave. If an incorrect slave address is written, the DS2741 assumes the master is communicating with another

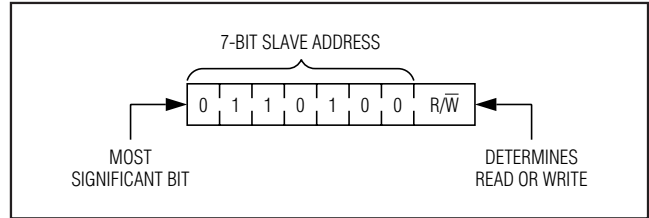

Figure 5. DS2741 Slave Address Byte

I<sup>2</sup>C device and ignores the communications until the next start condition is sent. This value can be changed at the factory to match the user's need. Contact the factory for more details on custom I<sup>2</sup>C device addresses for the DS2741.

**Memory Address:** During an I<sup>2</sup>C write operation, the master must transmit a memory address to identify the memory location where the slave is to store the data. The memory address is always the second byte transmitted during a write operation following the slave address byte.

## I<sup>2</sup>C Communication

See Figure 6 for examples of I<sup>2</sup>C communication.

**Writing a Single Byte to a Slave:** The master must generate a START condition, write the slave address byte (R/W = 0), write the memory address, write the byte of data, and generate a STOP condition. Remember that the master must read the slave's acknowledgement during all byte-write operations.

**Writing Multiple Bytes to a Slave:** To write multiple bytes to a slave, the master generates a START condition, writes the slave address byte (R/W = 0), writes the memory address, writes up to 8 data bytes, and generates a STOP condition.

**Reading a Single Byte from a Slave:** Unlike the write operation that uses the memory address byte to define where the data is to be written, the read operation occurs at the present value of the memory address counter. To read a single byte from the slave the master generates a START condition, writes the slave address byte with R/W = 1, reads the data byte with a NACK to indicate the end of the transfer, and generates a STOP condition.

**Manipulating the Address Counter for Reads:** A dummy write cycle can be used to force the address counter to a particular value. To do this the master generates a START condition, writes the slave address byte (R/W = 0), writes the memory address where it desires to read, generates a repeated START condition, writes the slave address byte (R/W = 1), reads data with ACK or NACK as applica-



# Current Monitor and Accumulator with Integrated Sense Resistor

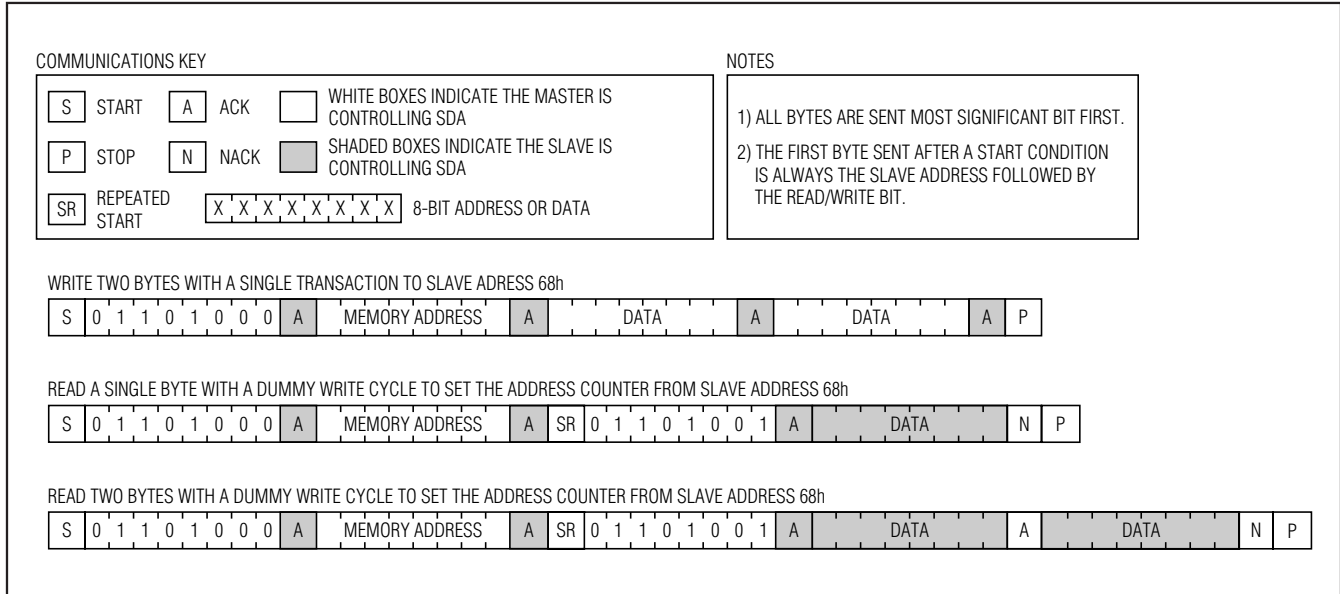

Figure 6. I<sup>2</sup>C Communications Examples

ble, and generates a STOP condition. See Figure 6 for a read example using the repeated START condition to specify the starting memory location.

**Reading Multiple Bytes from a Slave:** The read operation can be used to read multiple bytes with a single transfer. When reading bytes from the slave, the master simply ACKs the data byte if it desires to read another byte before terminating the transaction. After the master reads the last byte, it NACKs to indicate the end of the transfer and generates a STOP condition. This can be done with or without modifying the address counter's location before the read cycle. The DS2741's address counter does not wrap on page boundaries during read operations, but the counter rolls from its uppermost memory address FFh to 00h if the last memory location is read during the read transaction.

## Applications Information

### Power-Supply Decoupling

To achieve best results, it is recommended that the power supply is decoupled with a 0.01µF or a 0.1µF capacitor. Use high-quality, ceramic, surface-mount capacitors, and mount the capacitors as close as possible to the VCC and GND pins to minimize lead inductance.

### SDA and SCL Pullup Resistors

SDA is an open-collector output on the DS2741 that requires a pullup resistor to realize high logic levels. A master using either an open-collector output with a pullup resistor or a push-pull output driver can be used for SCL. Pullup resistor values should be chosen to ensure that the rise and fall times listed in the AC electrical characteristics are within specification.

## Package Information

For the latest package outline information and land patterns, go to [www.maxim-ic.com/packages](http://www.maxim-ic.com/packages).

PACKAGE TYPE	PACKAGE CODE	DOCUMENT NO.
14 TDFN-EP	T1433+2	<a href="#">21-0137</a>

# Current Monitor and Accumulator with Integrated Sense Resistor

## Revision History

REVISION NUMBER	REVISION DATE	DESCRIPTION	PAGES CHANGED
0	8/08	Initial release.	—
1	7/09	<ul style="list-style-type: none"> <li>• Current-Sense Accuracy specification at +25°C maximum limit changed to <math>\pm 3\%</math> in the <i>DC Electrical Characteristics</i>.</li> <li>• Current-Sense Accuracy specification from 0°C to +70°C maximum limit changed to <math>\pm 5\%</math> in the <i>DC Electrical Characteristics</i>.</li> <li>• Current-Sense Offset minimum specification changed to -20mA and the maximum specification changed to +20mA in the <i>DC Electrical Characteristics</i>.</li> </ul>	2

Maxim cannot assume responsibility for use of any circuitry other than circuitry entirely embodied in a Maxim product. No circuit patent licenses are implied. Maxim reserves the right to change the circuitry and specifications without notice at any time.

10 \_\_\_\_\_ **Maxim Integrated Products, 120 San Gabriel Drive, Sunnyvale, CA 94086 408-737-7600**